





COST ACCOUNTING Summary
تلخيص مادة محاسبة التكاليف

ACCT_331
كوست

ضياء الدين صبح 

- ✓ التلخيص شامل لشرح الكتاب + الدكتور (التلخيص كافي ولكن يفضل الرجوع الى فورمات للأهمية وكذلك الأمر أية أسئلة أخرى) 
- ✓ التلخيص خاص "تم نشره للإستفادة" ، ليس لي أي علاقة في كيفية دراستك للتلخيص و علاماتك (يعني إذا ما درست ما تحط الحق ع ضياء  ) 

النسخة الإلكترونية متوفرة فقط في BZU_HUB

CHAPTER 1

Introduction to Cost Accounting

مقدمة في محاسبة التكاليف

ضياء الدين صبح

Accounting Discipline Overview نظرة بشكل عام على المحاسبة

ž **Financial accounting**-focuses on reporting to external users including investors, creditors, banks, suppliers, and governmental agencies. **Financial statements must be based on GAAP.**

المحاسبة المالية - تركز على تقديم التقارير إلى المستخدمين الخارجيين بما في ذلك المستثمرين والدائنين والبنوك والموردين والوكالات الحكومية. يجب أن تستند البيانات المالية إلى مبادئ المحاسبة المقبولة عموماً.

ž **Management accounting**- measures, analyzes, and reports financial and nonfinancial information to help managers make decisions to fulfill organizational goals. **Management accounting need not be GAAP compliant. (Internal Users)**

المحاسبة الإدارية- يقيس ويحلل ويبلغ عن المعلومات المالية وغير المالية لمساعدة المديرين على اتخاذ القرارات لتحقيق الأهداف التنظيمية. لا يلزم أن تكون المحاسبة الإدارية متوافقة مع GAAP. **(للمستخدمين الداخليين)**

Accounting systems are used to record economic events and transactions such as sales and the purchases of materials and then process the data into a format that is helpful for managers and others.

أنظمة المحاسبة تُستخدم لتسجيل الأحداث والمعاملات الاقتصادية مثل المبيعات ومشتريات المواد ثم معالجة البيانات في شكل مفيد للمديرين وغيرهم.

Management accounting is the process of measuring, analyzing and reporting financial and nonfinancial information that helps managers make decisions.

المحاسبة الإدارية هي عملية قياس وتحليل والإبلاغ عن المعلومات المالية وغير المالية التي تساعد المديرين على اتخاذ القرارات.

Financial accounting has a focus on the financial information that is disseminated to external parties such as investors, government agencies, banks and suppliers.

المحاسبة المالية تركز على المعلومات المالية التي يتم نشرها إلى أطراف خارجية مثل المستثمرين والهيئات الحكومية والبنوك والموردين.

ž **Cost accounting – محاسبة التكاليف**

■ **measures, analyzes and reports financial and nonfinancial information related to the costs of acquiring or using resources in an organization.**

يقيس ويحلل ويبلغ عن المعلومات المالية وغير المالية المتعلقة بتكاليف الحصول على أو استخدام الموارد في المنظمة.

■ **Supports both financial accounting and management accounting. Examples:**

يدعم كلاً من المحاسبة المالية والمحاسبة الإدارية. **أمثلة:**

○ **Financial Accounting:** Cost per unit is used to calculate C.G.S (I/S) and ending inventory (B/S).

المحاسبة المالية: يتم استخدام التكلفة لكل وحدة لحساب C.G.S (I/S) وإنهاء المخزون (B/S).
مثال آخر عليها: مواد المحاسبة لدينا مثل: أكاونت 1 + 2 ، انترميديت 1 + 2 ، أدفانس .

○ **Management Accounting:** Cost per unit is used in pricing decisions.

المحاسبة الإدارية: يتم استخدام التكلفة لكل وحدة في قرارات التسعير.

مثالها ينحصر على المستوى الإداري: (مثل Department , CFO , CEO)

Cost accounting provides information for both management and financial accounting professionals has its focus on the costs of acquiring or using resources in the organization.

توفر محاسبة التكاليف معلومات لكل من محترفي المحاسبة الإدارية والمالية وتركز على تكاليف الحصول على الموارد أو استخدامها في المنظمة.

Note: As a reminder, the financial statements contain:

ملاحظة: للتذكير القوائم المالية تحتوي على

- | | |
|---------------------------|---------------------|
| 1. Income Statement (I/S) | بيان الدخل |
| 2. Owners' Equity (O/E) | حقوق الملكية |
| 3. Balance Sheet (B/S) | الميزانية العمومية |
| 4. Cash Flow (SCFs) | التدفق النقدي |
| 5. Note Disclosure(N/D) | الإفصاح عن البيانات |

Note: C.G.S is Cost of Goods Sold ملاحظة: هي تكلفة البضائع المباعة

Major differences between management and financial accounting

الاختلافات الرئيسية بين المحاسبة الإدارية والمالية

	Management Accounting المحاسبة الإدارية	Financial Accounting المحاسبة المالية
Purpose of information الغرض من المعلومات	Help managers make decisions to fulfill an organization's goals مساعدة المديرين على اتخاذ القرارات لتحقيق أهداف المنظمة	Communicate an organization's financial position to investors, banks, regulators, and other outside parties إبلاغ المركز المالي للمؤسسة للمستثمرين والبنوك والجهات التنظيمية والأطراف الخارجية الأخرى
Primary users المستخدمون الأساسيون	Managers of the organization مدير و المنظمة	External users such as investors, banks, regulators, and suppliers المستخدمون الخارجيون مثل المستثمرين والبنوك والمنظمين والموردين
Focus and emphasis التركيز	Future-oriented (budget for 2014 prepared in 2013) موجه نحو المستقبل (ميزانية 2014 أعدت في 2013)	Past-oriented (reports on 2013 performance prepared in 2014) الماضي المنحى (تقارير عن أداء 2013 أعدت في 2014)
Rules of measurement and reporting قواعد القياس والإبلاغ	internal measures and reports do not have to follow GAAP but are based on cost-benefit analysis لا يتعين على التدابير والتقارير الداخلية اتباع مبادئ المحاسبة المقبولة عموماً ولكنها تستند إلى تحليل التكلفة والعائد	Financial statements must be prepared in accordance with GAAP and be certified by external, independent auditors يجب أن يتم إعداد البيانات المالية وفقاً لمبادئ المحاسبة المقبولة عموماً وأن تكون معتمدة من قبل مدققين خارجيين ومستقلين
Time span and type of reports الفترة الزمنية ونوع التقارير	Varies from hourly information to 15 to 20 years, with financial and nonfinancial reports on products, departments, territories, and strategies يختلف من المعلومات كل ساعة إلى 15 إلى 20 عامًا ، مع التقارير المالية وغير المالية حول المنتجات والإدارات والأقاليم والاستراتيجيات	Annual and quarterly financial reports, primarily on the company as a whole تقارير مالية سنوية وربع سنوية ، بشكل أساسي عن الشركة ككل
Behavioral implications الآثار السلوكية	Designed to influence the behavior of managers and other employees مصممة للتأثير على سلوك المديرين والموظفين الآخرين	Primarily reports economic events but also influences behavior because manager's compensation is often based on reported financial results تقوم بشكل أساسي بالإبلاغ عن الأحداث الاقتصادية ولكنها تؤثر أيضاً على السلوك لأن تعويض المدير غالباً ما يعتمد على النتائج المالية المبلغ عنها

تحليل سلسلة القيمة Value Chain Analysis

z The Value Chain is the sequence of business functions in which a product is made progressively more useful to customers.

سلسلة القيمة هي تسلسل وظائف العمل التي يصبح فيها المنتج أكثر فائدة للعملاء بشكل تدريجي.

The Value chain consists of: تتكون سلسلة القيمة من

1. Research & development (generating and experimenting with ideas related to new products, services or processes)
البحث والتطوير (توليد الأفكار المتعلقة بالمنتجات أو الخدمات أو العمليات الجديدة وتجريبها)
2. Design of Products and Processes (detailed planning, engineering and testing of products and processes)
تصميم المنتجات والعمليات (التخطيط التفصيلي والهندسة واختبار المنتجات والعمليات)

CH1 - ACCT335 (COST) تلخيص

ضياء الدين صبح

- 3. Production** (procuring, transporting and storing, coordinating and assembling resources to produce a product or deliver a service)
الإنتاج (شراء ونقل وتخزين وتنسيق وتجميع الموارد لإنتاج منتج أو تقديم خدمة)
- 4. Marketing** (promoting and selling products or services)
التسويق (ترويج وبيع المنتجات أو الخدمات)
- 5. Distribution** (processing orders and shipping products or services to customers)
التوزيع (معالجة الطلبات وشحن المنتجات أو الخدمات للزبائن)
- 6. Customer service** (providing after-sales service to customers)
خدمة الزبائن (تقديم خدمة ما بعد البيع للزبائن)

Here we have a pictorial view of the value chain. In addition to each of our functions previously discussed, you see "administration" as an additional function. This includes accounting, human resources, information technology and supports the six primary business functions.

لدينا هنا رؤية مصورة لسلسلة القيمة. بالإضافة إلى كل وظيفة من وظائفنا التي تمت مناقشتها سابقاً، نرى "الإدارة" كوظيفة إضافية. وهذا يشمل المحاسبة والموارد البشرية وتكنولوجيا المعلومات ويدعم وظائف الأعمال الأساسية الست.

Management accounting provides information to inform each of these functions in the value chain

توفر المحاسبة الإدارية معلومات لإبلاغ كل من هذه الوظائف في سلسلة القيمة

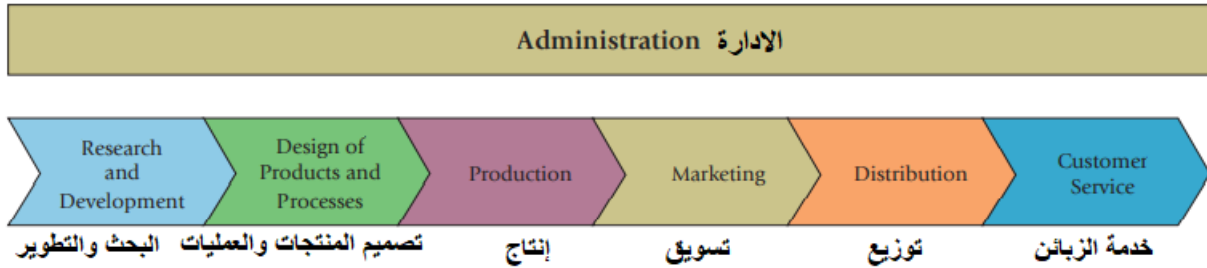

الأسئلة الإضافية Additional Question

Q1: Circle the correct answer

1) Management accounting:

- A) focuses on estimating future revenues, costs, and other measures to forecast activities and their results**
- B) provides information about the company as a whole
- C) reports information that has occurred in the past that is verifiable and reliable
- D) provides information that is generally available only on a quarterly or annual basis

2) Financial accounting:

- A) focuses on the future and includes activities such as preparing next year's operating budget
- B) must comply with GAAP (generally accepted accounting principles)**
- C) reports include detailed information on the various operating segments of the business such as product lines or departments
- D) is prepared for the use of department heads and other employees

3) Which of the following statements refers to management accounting information?

- A) There are no regulations governing the reports.**
- B) The reports are generally delayed and historical.
- C) The audience tends to be stockholders, creditors, and tax authorities.
- D) It primarily measures and records business transactions.

ضياء الدين صبح

- 4) **Cost accounting:**
- A) provides information on the efficiency of factory labor
 - B) provides information on the cost of servicing commercial customers
 - C) provides information on the performance of an operating division
 - D) All of these answers are correct.**
- 5) **Which of the following types of information are used in management accounting?**
- A) financial information
 - B) nonfinancial information
 - C) information focused on the long term
 - D) All of these answers are correct**
- 6) **Management accounting includes all of the following EXCEPT**
- A) implementing strategies
 - B) developing budgets
 - C) preparing special studies and forecasts
 - D) preparing the statement of cash flows**
- 7) _____ is the generation of, and experimentation with, ideas related to new products, services, or processes.
- A) Research and development**
 - B) Design of products, services, or processes
 - C) Production
 - D) Marketing
- 8) _____ is the acquisition, coordination, and assembly of resources to produce a product or deliver a service.
- A) Research and development
 - B) Customer service
 - C) Production**
 - D) Marketing
- 9) _____ is the after-sale support provided to customers.
- A) Distribution
 - B) Customer service**
 - C) Production
 - D) Marketing
- 10) **Cost accounting provides all of the following EXCEPT:**
- A) information for management accounting and financial accounting
 - B) pricing information from marketing studies**
 - C) financial information regarding the cost of acquiring resources
 - D) nonfinancial information regarding the cost of operational efficiencies

Q2: Indicate whether each of the following statements is true or false.

- False** 1. Management accounting information focuses on external reporting.
- True** 2. The balance sheet, income statement, and statement of cash flows are used for financial accounting, and also for management accounting.
- False** 3. The supply chain refers to the sequence of business functions in which customer usefulness is added to products or services.
- False** 4 Distribution refers to promoting and selling products or services to customers or prospective customers

ضياء الدين صبح

False 5. Value chain refers to its value to the employee.

Q3: Classify each cost item of Ripon Printers into one of the business functions of the value chain, either (1) R&D, (2) design, (3) production, (4) marketing, (5) distribution, or (6) customer service.

قم بتصنيف كل عنصر تكلفة لطابعات Ripon إلى إحدى وظائف الأعمال لسلسلة القيمة ، إما (1) البحث والتطوير ، (2) التصميم ، (3) الإنتاج ، (4) التسويق ، (5) التوزيع ، أو (6) خدمة الزبائن.

Item:

- a. cost of customer order forms تكلفة نماذج طلب الزبون
- b. cost of paper used in manufacture of books تكلفة الورق المستخدم في صناعة الكتب
- c. cost of paper used in packing cartons to ship books تكلفة الورق المستخدم في تعبئة الكراتين لشحن الكتب
- d. cost of paper used in display at national trade show تكلفة الورق المستخدم في العرض في المعرض التجاري الوطني
- e. depreciation of trucks used to transport books to college bookstores استهلاك الشاحنات المستخدمة في نقل الكتب إلى مكتبات الكلية
- f. cost of the wood used to manufacture paper تكلفة الخشب المستخدم في صناعة الورق
- g. salary of the scientists attempting to find another source of printing ink راتب العلماء الذين يحاولون إيجاد مصدر آخر لحبر الطباعة
- h. cost of defining the book size so that a standard-sized box is filled to capacity تكلفة تحديد حجم الكتاب بحيث يتم ملء الصندوق القياسي بالحجم السعة

Answer:

- a. (4) marketing
- b. (3) production
- c. (5) distribution
- d. (4) marketing
- e. (5) distribution
- f. (3) production
- g. (1) research and development
- h. (2) design

END OF CHAPTER 1

CHAPTER 2

An Introduction to Cost Terms and Purposes

مقدمة لشروط وأغراض
التكلفة

ضياء الدين صبح

Basic Cost Terminology مصطلحات التكلفة الأساسية

- Ž **Cost**—a sacrificed or forgone resource to achieve a specific objective.
التكلفة - مورد تم التضحية به أو تم التخلي عنه لتحقيق هدف محدد. (يعني انا بتخلي عن اشي عشان اؤخذ اشي ثاني)
- Ž **Actual cost**—a cost that has occurred
التكلفة الفعلية - تكلفة حدثت
- Ž **Budgeted cost**—a predicted cost. (Not happened)
التكلفة المدرجة في الميزانية - تكلفة متوقعة
مثلا : انا ضحيت ب 10 شيفل عشان اجي ع الجامعة (فعلية) بس لما اروح بدي ادفع كمان 10 شيفل (متوقعة)
- Ž **Cost object**—anything for which a cost measurement is desired.
كائن التكلفة - أي شيء مطلوب قياس التكلفة له. (اي اشي منقيس عليه التكلفة: سيارة ، علبة عصير أو كولا أو الخ...
 - Product: BMW X6 على سبيل المثال المنتج بي ام دبليو اكس 6
 - Department: Assembly القسم: التجميع / التركيب
 - Project: R&D project on DVD system enhancement in BMW cars المشروع: مشروع البحث والتطوير الخاص بتحسين نظام DVD في سيارات BMW

Note: Managers use cost information in two main ways: when MAKING decisions and when IMPLEMENTING decisions

يستخدم المديرين معلومات التكلفة بطريقتين رئيسيتين: عند اتخاذ القرارات وعند تنفيذ القرارات

Here, we have some additional terminology: هنا ، لدينا بعض المصطلحات الإضافية:

- **Cost accumulation**—a collection of cost data in an organized way by means of an accounting system
تراكم التكلفة - مجموعة من بيانات التكلفة بطريقة منظمة عن طريق نظام محاسبية
- **Cost assignment**—a general term that encompasses the gathering of accumulated costs to a cost object in two ways:
تعيين التكلفة - مصطلح عام يشمل تجميع التكاليف المتراكمة إلى كائن تكلفة بطريقتين:
 - Ž **Tracing accumulated costs with a direct relationship to the cost object**
تتبع التكاليف المتراكمة بعلاقة مباشرة بكائن التكلفة
 - Ž **Allocating accumulated costs with an indirect relationship to a cost object**
تخصيص التكاليف المتراكمة بعلاقة غير مباشرة مع كائن التكلفة

Direct and Indirect Costs التكاليف المباشرة وغير المباشرة

- Ž **Direct costs** التكاليف المباشرة
 - can be conveniently and economically traced (tracked) to a cost object.
يمكن تتبعه بشكل ملائم واقتصادي (تعبه) لكائن التكلفة. (على سبيل المثال: تكلفة علبة العصير حسب خط الإنتاج)
- Ž **Indirect costs** التكاليف غير مباشرة
 - cannot be conveniently or economically traced (tracked) to a cost object.
لا يمكن تتبعه (تعبه) بشكل ملائم أو اقتصادي لكائن تكلفة. (مثل : الكهرباء في المصنع ككل وليس لخط الإنتاج)
 - Instead of being traced, these costs are allocated to a cost object in a rational and systematic manner.
بدلاً من تتبعها ، يتم تخصيص هذه التكاليف لكائن التكلفة بطريقة منطقية ومنهجية.

The salary of a plant administrator at BMW, as an example, is an indirect cost of a particular automobile because unlike the steel or tires used, it is virtually impossible to trace plant administration to a particular car line.

راتب مسؤول المصنع في BMW ، على سبيل المثال ، هو تكلفة غير مباشرة لسيارة معينة لأنه على عكس الفولاذ أو الإطارات المستخدمة ، يكاد يكون من المستحيل تتبع إدارة المصنع لخط سيارة معين.

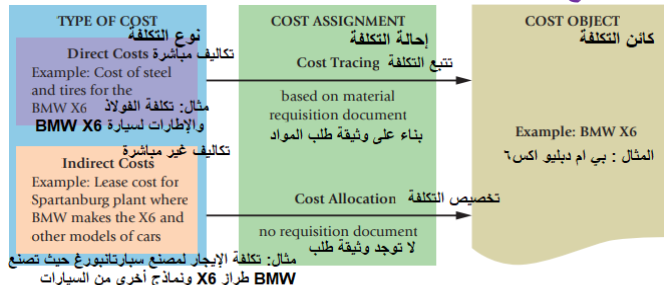

ضياء الدين صبح

Cost Examples أمثلة على التكاليف

Direct Costs التكاليف المباشرة

- Parts (steel or tires for a car, as an example) قطع غيار (فولاذ أو إطارات للسيارة ، كمثال)
- Assembly line wages أجور خط التجميع

Indirect Costs التكاليف الغير مباشرة

- Electricity الكهرباء
- Rent تأجير
- Property taxes الضرائب العقارية
- Plant administration expenses مصاريف إدارة المصنع

Note of the example Costs: ملاحظات عن الأمثلة

- One way to think about this is that association between the direct costs and the specific request for those items in the production process. We need 4 tires and x lbs of steel for each car, but we don't requisition some number of hours of administration time or rent for each car or for the line. تتمثل إحدى طرق التفكير في هذا في الارتباط بين التكاليف المباشرة والطلب المحدد لتلك العناصر في عملية الإنتاج. نحتاج إلى 4 إطارات و x رطل من الفولاذ لكل سيارة ، لكننا لا نطلب عددًا من ساعات الإدارة أو الإيجار لكل سيارة أو للخط.
- Managers are generally more confident about the accuracy of the direct costs of cost objects. المديرين بشكل عام أكثر ثقة بشأن دقة التكاليف المباشرة لأجسام التكلفة.

Factors Affecting Direct/Indirect Cost Classification العوامل المؤثرة في تصنيف التكلفة المباشرة / غير المباشرة

- The materiality of the cost in question (the smaller the cost, the less likely it will be efficient to trace the cost)** الأهمية النسبية للتكلفة المعنية (كلما قلت التكلفة ، قل احتمال أن يكون تتبع التكلفة فعالاً)
- The available information-gathering technology (technology allows us to treat more and more costs as direct)** تكنولوجيا جمع المعلومات المتاحة (تتيح لنا التكنولوجيا التعامل مع المزيد والمزيد من التكاليف على أنها مباشرة)
- Design of operations (if parts of a facility are dedicated to a particular cost object, we are generally able to classify more costs as direct)** تصميم العمليات (إذا كانت أجزاء من المنشأة مخصصة لكائن تكلفة معين ، فنحن قادرون بشكل عام على تصنيف المزيد من التكاليف على أنها مباشرة)

NOTE: a specific cost may be both a direct cost of one cost object and an indirect cost of another cost object.

ملاحظة: قد تكون التكلفة المحددة عبارة عن تكلفة مباشرة لكائن تكلفة واحد وتكلفة غير مباشرة لكائن تكلفة آخر. على سبيل المثال : قد تكون تكلفة الكهرباء مباشرة لخط الإنتاج الواحد و تكون غير مباشرة اذا كانت لمصنع كامل.

For example, the salary of an assembly department supervisor at BMW is a direct cost if the cost object is the assembly department. على سبيل المثال ، يعتبر راتب مشرف قسم التجميع في BMW تكلفة مباشرة إذا كان كائن التكلفة هو قسم التجميع.

Cost Behavior سلوك التكلفة

- Variable costs—change in total in proportion to changes in the related level of activity or volume of output produced.** التكاليف المتغيرة - التغيير في المجموع بما يتناسب مع التغييرات في مستوى النشاط ذي الصلة أو حجم الإنتاج المنتج.
- Fixed costs—remain unchanged in total, for a given time period, despite changes in the related level of activity or volume of output produced.** التكاليف الثابتة - تظل دون تغيير في المجموع ، لفترة زمنية معينة ، على الرغم من التغييرات في مستوى النشاط ذي الصلة أو حجم الإنتاج المنتج.
- Costs are fixed or variable only with respect to a specific activity or a given time period. التكاليف ثابتة أو متغيرة فقط فيما يتعلق بنشاط معين أو فترة زمنية معينة.

CH2 - ACCT335 (COST) تلخيص

ضياء الدين صبح

When considering variable and fixed costs, it is very important to know if you are looking at the cost IN TOTAL or PER UNIT.

عند التفكير في التكاليف المتغيرة والثابتة ، من المهم جدًا معرفة ما إذا كنت تبحث عن التكلفة الإجمالية أو الكلية.

‣ **Variable costs** are constant on a per-unit basis. If a product takes 5 pounds of materials each, it stays the same per unit regardless if one, ten, or a thousand units are produced.

التكاليف المتغيرة ثابتة على أساس كل وحدة. إذا أخذ منتج ما 5 أرطال من المواد لكل منهما ، فإنه يظل كما هو لكل وحدة بغض النظر عما إذا تم إنتاج وحدة أو عشرة أو ألف وحدة.

‣ **Fixed costs** per unit change inversely with the level of production. As more units are produced, the same fixed cost is spread over more and more units, reducing the cost per unit.

التكاليف الثابتة لكل وحدة تتغير عكسيا مع مستوى الإنتاج. مع إنتاج المزيد من الوحدات ، يتم توزيع نفس التكلفة الثابتة على المزيد والمزيد من الوحدات ، مما يقلل التكلفة لكل وحدة.

Cost Behavior Summarized تلخيص سلوك التكلفة

	Total Dollars إجمالي \$\$\$ "التكلفة"	Cost Per Unit التكلفة لكل وحدة
Variable Costs التكاليف المتغيرة	<p>Change in proportion with output التغيير بما يتناسب مع الناتج More output = More cost المزيد من الإنتاج = المزيد من التكلفة</p>	<p>Unchanged in relation to Output دون تغيير بالنسبة للإخراج</p>
Fixed Costs التكاليف الثابتة	<p>Unchanged in relation to output دون تغيير بالنسبة للإخراج</p>	<p>Change inversely with output تغيير عكسيا مع الإخراج More output = lower cost per unit المزيد من الإنتاج = تكلفة أقل لكل وحدة</p>

Graphs of variable and fixed costs الرسوم البيانية للتكاليف المتغيرة والثابتة

PANEL A: Variable Cost of Steering Wheels at \$60 per BMW X6 Assembled

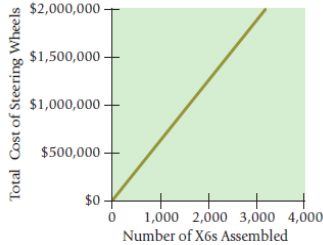

PANEL B: Supervision Costs for the BMW X6 assembly line (in millions)

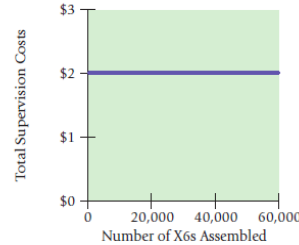

☞ In these charts, we see the graphs for variable and fixed costs using the number of steering wheels for the BMW X6.

في هذه الرسوم البيانية ، نرى الرسوم البيانية للتكاليف المتغيرة والثابتة باستخدام عدد عجلات القيادة لسيارة BMW X6.

☞ Panel A shows a graph of the total variable cost of steering wheels. The cost begins at zero because if we make no X6s, we'll incur no cost for the steering wheels.

تعرض اللوحة A رسماً بيانياً لإجمالي التكلفة المتغيرة لعجلات القيادة. تبدأ التكلفة من الصفر لأننا إذا لم نصنع سيارات X6 ، فلن نتحمل أي تكلفة على عجلات القيادة.

☞ Fixed Costs are presented in Panel B where we have a line across at the \$2,000,000 mark. The Annual total fixed supervision costs for the X6 are that amount and will be that amount whether we assemble zero, 20,000, 40,000 or 60,000 cars.

يتم عرض التكاليف الثابتة في اللوحة (ب) حيث لدينا خط عبر علامة 2,000,000 دولار. إجمالي تكاليف الإشراف الثابت السنوي لـ X6 هو هذا المبلغ وسيكون هذا المبلغ سواء قمنا بتجميع صفر أو 20,000 أو 40,000 أو 60,000 سيارة.

A Cost Caveat تحذير من التكلفة

‣ **Unit costs** should be used cautiously. **Because unit costs** change with a different level of output or volume, it may be more prudent to base decisions on a total cost basis.

ضياء الدين صبح

يجب استخدام تكاليف الوحدة بحذر. نظرًا لأن تكاليف الوحدة تتغير بمستوى مختلف من الإنتاج أو الحجم ، فقد يكون من الحكمة اتخاذ القرارات على أساس التكلفة الإجمالية.

- Unit costs that include fixed costs should always reference a given level of output or activity.
يجب أن تشير تكاليف الوحدة التي تتضمن تكاليف ثابتة دائمًا إلى مستوى معين من الإنتاج أو النشاط.
- Unit costs are also called average costs.
تسمى تكاليف الوحدة أيضًا متوسط التكاليف
- Managers should think in terms of total costs rather than unit costs for many decisions.
يجب على المديرين التفكير من حيث التكاليف الإجمالية بدلاً من تكاليف الوحدة للعديد من القرارات.
اختصار التحذير هو Misleading يعني مضللة

Other Cost Concepts مفاهيم التكلفة الأخرى

Cost driver— سائق التكلفة

- a variable, such as the level of activity or volume, that causally affects costs over a given time span.
عنصر Factor/element ، مثل مستوى النشاط أو الحجم ، يؤثر سببًا على التكاليف خلال فترة زمنية معينة. (المسبب)
- Examples. designing products, setting up machines, or testing products.
أمثلة. تصميم المنتجات أو تركيب الآلات أو اختبار المنتجات.

Relevant range— الطاقة الإنتاجية

- the band or range of normal activity level (or volume) in which there is a specific relationship between the level of activity (or volume) and the cost in question.
النطاق أو النطاق لمستوى النشاط العادي (أو الحجم) الذي توجد فيه علاقة محددة بين مستوى النشاط (أو الحجم) والتكلفة المعنية.
- For example, fixed costs are considered fixed only within the relevant range.
على سبيل المثال ، تعتبر التكاليف الثابتة ثابتة فقط في الطاقة الإنتاجية.

Multiple Classifications of Costs تصنيفات متعددة للتكاليف

Costs may be classified as: يمكن تصنيف التكاليف على النحو التالي

- Direct/Indirect مباشر / غير مباشر
- Variable/Fixed متغير / ثابت

These multiple classifications give rise to important cost combinations:

تؤدي هذه التصنيفات المتعددة إلى مجموعات تكلفة مهمة:

- Direct and variable مباشر ومتغير
- Direct and fixed مباشر وثابت
- Indirect and variable غير مباشر ومتغير
- Indirect and fixed غير مباشر وثابت

Examples of the Multiple Classifications of Costs أمثلة على التصنيفات المتعددة للتكاليف

		Assignment of Costs to Cost Object تعيين التكاليف لكائن التكلفة	
		Direct Costs التكاليف المباشرة	Indirect Costs التكاليف الغير مباشرة
Cost Behavior Pattern نمط سلوك التكلفة	Variable Costs التكاليف المتغيرة	Cost object: BMW X6s produced Example: Tires used in assembly of automobile مثال: الإطارات المستخدمة في تجميع السيارات	Cost object: BMW X6s produced Example: Power costs at Spartanburg plant. Power usage is metered only to the plant, where multiple products are assembled. مثال: تكاليف الطاقة في مصنع سبارتانبورغ. يتم قياس استخدام الطاقة في المصنع فقط ، حيث يتم تجميع العديد من المنتجات.
	Fixed Costs التكاليف الثابتة	Cost object: BMW X6s produced Example: Salary of supervisor on BMW X6 assembly line مثال: راتب المشرف على خط تجميع BMW X6	Cost object: BMW X6s produced Example: Annual lease costs at Spartanburg plant. Lease is for whole plant, where multiple products are produced.

مثال: تكاليف الإيجار السنوية في مصنع سيارتانبورغ. عقد الإيجار للمصنع بأكمله ، حيث يتم إنتاج العديد من المنتجات.

Different Types of Firms أنواع الشركات المختلفة

- ✘ **Service-sector companies** provide services (intangible products) like legal advice or audits. شركات قطاع الخدمات تقدم خدمات (منتجات غير ملموسة) مثل الاستشارات القانونية أو عمليات التدقيق. "التأمين"
- ✘ **Merchandising-sector companies** purchase and then sell tangible products without changing their basic form. (Finished Costs) شركات قطاع التجارة المنتجات الملموسة ثم تبيعها دون تغيير شكلها الأساسي. "مثل: محلات بيع القطع .. الخ"
- ✘ **Manufacturing-sector companies** purchase materials and components and convert them into finished products. شركات قطاع التصنيع تقوم بشراء المواد والمكونات وتحويلها إلى منتجات تامة الصنع. (مثل: الجنيدي ، الجبريني ... الخ)

Types of inventories أنواع المخزون

- ✘ **Direct materials (DM)**—resources in-stock and available for use المواد المباشرة - الموارد الموجودة في المخزن والمتاحة للاستخدام
- ✘ **Work-in-process (or progress) (WIP)**—products started but not yet completed, often abbreviated as WIP قيد التشغيل (أو قيد التنفيذ) - المنتجات التي بدأت ولكنها لم تكتمل بعد ، وغالبًا ما يتم اختصارها كـ WIP
- ✘ **Finished goods (F.G)**—products completed and ready for sale بضائع تامة الصنع - منتجات مكتملة وجاهزة للبيع " جاهزة ولكن ما انباعت لسا عنا بس جاهزة للبيع"

Note: Merchandising-sector companies hold only one type of inventory: **merchandise inventory** ملاحظة: تمتلك شركات قطاع التجارة نوعًا واحدًا فقط من المخزون: **مخزون البضائع**

Commonly used classifications of manufacturing costs التصنيفات الشائعة الاستخدام لتكاليف التصنيع

- ✘ **Also known as inventoriable costs** تُعرف أيضًا باسم التكاليف القابلة للجرد
 - **Direct materials**—acquisition costs of all materials that will become part of the cost object. المواد المباشرة - تكاليف اقتناء جميع المواد التي ستصبح جزءًا من كائن التكلفة.
 - **Direct labor**—compensation of all manufacturing labor that can be traced to the cost object. العمالة المباشرة - تعويض جميع العمالة التصنيعية التي يمكن إرجاعها إلى كائن التكلفة.
 - **Indirect manufacturing**—factory costs that are not traceable to the product in an economically feasible way. (MOH) التصنيع غير المباشر - تكاليف المصنع التي لا يمكن عزوها للمنتج بطريقة مجدية اقتصاديًا.
 - Examples include lubricants, indirect manufacturing labor, utilities, and supplies. تشمل الأمثلة مواد التشحيم ، والعمالة الصناعية غير المباشرة ، والمرافق ، والإمدادات.
 - **Called Manufacturing Overhead (MOH).** يسمى النفقات العامة للتصنيع

Inventoriable costs vs. period costs التكاليف القابلة للجرد مقابل تكاليف الفترة

- ✘ **Inventoriable costs** are all costs of a product that are considered assets in a company's balance sheet when the costs are incurred and that are expensed as cost of goods sold only when the product is sold. For manufacturing companies, all manufacturing costs are inventoriable costs. التكاليف القابلة للجرد هي جميع تكاليف المنتج التي تعتبر أصولاً في الميزانية العمومية للشركة عند تكبد التكاليف والتي يتم احتسابها كتكلفة للسلع المباعة فقط عند بيع المنتج. بالنسبة لشركات التصنيع ، تعتبر جميع تكاليف التصنيع تكاليف قابلة للجرد/التخزين .
- ✘ **Period costs** are all costs in the income statement other than cost of goods sold. They are treated as expenses of the accounting period in which they are incurred. تكاليف الفترة هي جميع التكاليف الواردة في بيان الدخل بخلاف تكلفة البضائع المباعة. يتم معاملتها كمصروفات الفترة المحاسبية التي يتم تكبدها فيها.

Cost Flows تدفقات التكلفة

- ✘ The Cost of Goods Manufactured and the Cost of Goods Sold section of the Income Statement are accounting representations of the actual flow of costs through a production system. يمثل قسم تكلفة السلع المصنعة وتكلفة البضائع المباعة في بيان الدخل تمثيلات محاسبية للتدفق الفعلي للتكاليف من خلال نظام الإنتاج.

CH2 - ACCT335 (COST) تلخيص

ضياء الدين صبح

- Note** how inventoriable costs to through the balance sheet accounts of work-in-process and finished goods inventory before entering the cost of goods sold in the income statement.
- لاحظ كيف يمكن الوصول إلى التكاليف القابلة للجرد من خلال حسابات الميزانية العمومية للعمل قيد التشغيل ومخزون البضائع التامة الصنع قبل إدخال تكلفة البضائع المباعة في بيان الدخل.

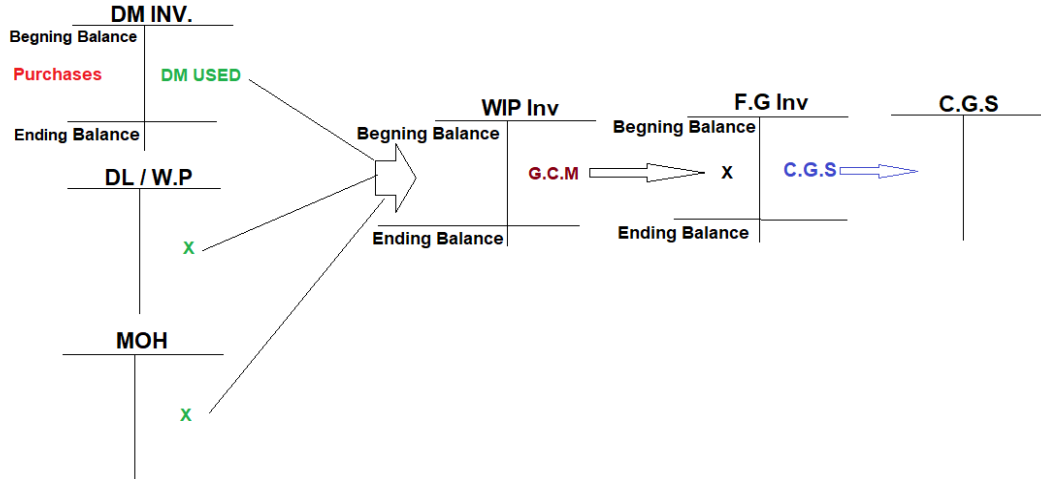

فكرة سلايد 21 مثلا (ع هاي الصورة)

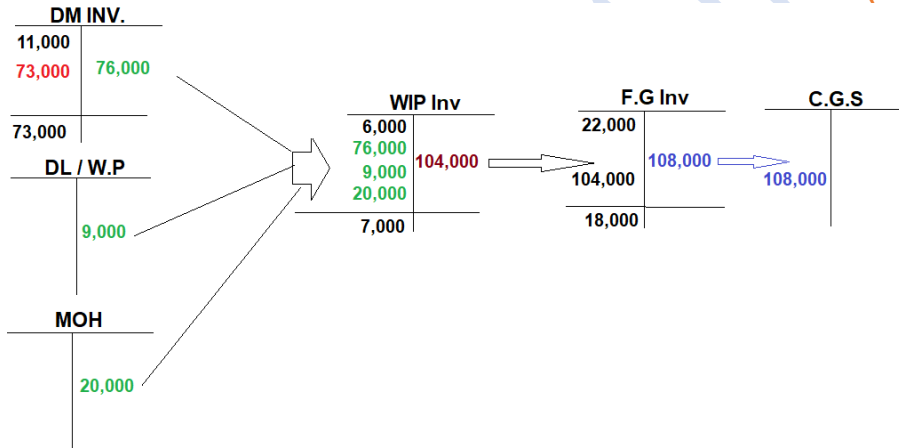

لو منا نحطهم بجدول رح يكونوا كذلك :

STEP 1		STEP 2		STEP 3	
18	PANEL B: COST OF GOODS MANUFACTURED				
19	Cellular Products				
20	Schedule of Cost of Goods Manufactured ^a				
21	For the Year Ended December 31, 2014 (in thousands)				
22	Direct materials:				
23	Beginning inventory, January 1, 2014	\$11,000			
24	Purchases of direct materials	73,000			
25	Cost of direct materials available for use	84,000			
26	Ending inventory, December 31, 2014	8,000			
27	Direct materials used		\$ 76,000		
28	Direct manufacturing labor		9,000		
29	Manufacturing overhead costs:				
30	Indirect manufacturing labor	\$ 7,000			
31	Supplies	2,000			
32	Heat, light, and power	5,000			
33	Depreciation—plant building	2,000			
34	Depreciation—plant equipment	3,000			
35	Miscellaneous	1,000			
36	Total manufacturing overhead costs		20,000		
37	Manufacturing costs incurred during 2014		105,000		
38	Beginning work-in-process inventory, January 1, 2014	6,000			
39	Total manufacturing costs to account for		111,000		
40	Ending work-in-process inventory, December 31, 2014	7,000			
41	Cost of goods manufactured (to income statement)		\$104,000		
42	^a Note that this schedule can become a schedule of cost of goods manufactured and sold simply by including the beginning and ending finished goods inventory figures in the supporting schedule rather than in the body of the income statement.				

	A	B	C	D
1	PANEL A: INCOME STATEMENT			
2	Cellular Products			
3	Income Statement			
4	For the Year Ended December 31, 2014 (in thousands)			
5	Revenues		\$210,000	
6	Cost of goods sold:			
7	Beginning finished goods inventory, January 1, 2014	\$ 22,000		
8	Cost of goods manufactured (see Panel B)	104,000		
9	Cost of goods available for sale	126,000		
10	Ending finished goods inventory, December 31, 2014	18,000		
11	Cost of goods sold		108,000	
12	Gross margin (or gross profit)		102,000	
13	Operating costs:			
14	R&D, design, mktg., dist., and cust.-service cost	70,000		
15	Total operating costs		70,000	
16	Operating income		\$ 32,000	

ضياء الدين صبح

Other Cost Considerations قضايا تكلفة اخرى

- ž **Prime cost (PC)** is a term referring to all direct manufacturing costs (materials and labor).
التكلفة الأولية هي مصطلح يشير إلى جميع تكاليف التصنيع المباشرة (المواد والعمالة).
- ž **Conversion cost (CC)** is a term referring to direct labor and indirect manufacturing costs.
تكلفة التحويل مصطلح يشير إلى العمالة المباشرة وتكاليف التصنيع غير المباشرة.
- ž **Overtime labor costs** are considered part of indirect overhead costs.
تكاليف العمالة الإضافية تعتبر جزءاً من التكاليف العامة غير المباشرة.

$$PC = DM \text{ used} + DL$$

$$CC = DL + MOH$$

ملاحظة في سؤال في آخر التشابتر (تم حله بالسؤال الثالث من الاسئلة الإضافية)
الخلاصة : كل قوانين التشابتر المطلوبة :

1. Beginning DM (Direct materials) + Purchases = Available for Use DM
2. Available for Use DM – Ending Dm = Dm Used
3. Dm Used + DL + MOH = Total Current Manufacturing
4. Beginning WIP + Total Current Manufacturing = Total WIP Inventory
5. Total WIP Inventory – Ending WIP = Cost Of Goods Manufacturing (C.G.M)
6. Cost Of Goods Manufacturing (C.G.M) + Beginning Finished Goods (F.G) = Total F.C Available for sale
7. Total F.C Available for sale – Ending F.G = Cost Of Goods Sold (C.G.S)
8. Prime cost (PC) = Dm Used + DL
9. Conversion cost (CC) = DL + MOH

Additional Question الأسئلة الإضافية

Q1: Circle the correct answer

1) Cost objects include:

- a) products
- b) customers
- c) departments
- d) All of these answers are correct.**

2) Budgeted costs are:

- a) the costs incurred this year
- b) the costs incurred last year
- c) planned or forecasted costs**
- d) competitor's costs

3) Cost assignment:

- a) is always arbitrary
- b) is includes tracing and allocating**
- c) is the same as cost accumulation
- d) is finding the difference between budgeted and actual costs

4) Cost tracing is:

- a) the assignment of direct costs to the chosen cost object**
- b) a function of cost allocation
- c) the process of tracking both direct and indirect costs associated with a cost object
- d) the process of determining the actual cost of the cost object

ضياء الدين صبح

- 5) Cost behavior refers to:
- how costs react to a change in the level of activity
 - whether a cost is incurred in a manufacturing, merchandising, or service company
 - classifying costs as either inventoriable or period costs
 - whether a particular expense has been ethically incurred
- 6) If each motorcycle requires a belt that costs \$20 and 2,000 motorcycles are produced for the month, the total cost for belts is:
- considered to be a direct fixed cost
 - considered to be a direct variable cost
 - considered to be an indirect fixed cost
 - considered to be an indirect variable cost
- 7) A band of normal activity or volume in which specific cost-volume relationships are maintained is referred to as the:
- average range
 - cost-allocation range
 - cost driver range
 - relevant range
- 8) When 20,000 units are produced, fixed costs are \$16 per unit. Therefore, when 40,000 units are produced fixed costs will:
- increase to \$32 per unit
 - remain at \$16 per unit
 - decrease to \$8 per unit
 - total \$640,000
- 9) When 10,000 units are produced, variable costs are \$6 per unit. Therefore, when 20,000 units are produced:
- variable costs will total \$120,000
 - variable costs will total \$60,000
 - variable unit costs will increase to \$12 per unit
 - variable unit costs will decrease to \$3 per unit
- 10) _____ - sector companies purchase materials and components and convert them into finished goods.
- Merchandising
 - Service
 - Manufacturing
 - Professional
- 11) _____ - sector companies provide intangible products.
- Professional
 - Manufacturing
 - Merchandising
 - Service
- 12) Manufacturing overhead costs are also referred to as:
- indirect manufacturing costs
 - prime costs
 - period costs
 - direct material

ضياء الدين صبح

13) Merchandising companies normally report:

- a) **only merchandise inventory**
- b) only finished goods inventory
- c) direct materials inventory, work-in-process inventory, and finished goods inventory accounts
- d) no inventory accounts

14) Finished goods inventory would normally include:

- a) direct materials in stock and awaiting use in the manufacturing process
- b) goods partially worked on but not yet fully completed
- c) **goods fully completed but not yet sold**
- d) products in their original form intended to be sold without changing their basic form

15) _____ are the acquisition costs of all materials that eventually become part of the cost object and can be traced to the cost object.

- a) Direct manufacturing labor costs
- b) **Direct material costs**
- c) Indirect manufacturing costs
- d) Manufacturing overhead costs

16) Costs that are initially recorded as assets and expensed when sold are called:

- a) period costs
- b) **inventoriable costs**
- c) variable costs
- d) fixed costs

17) Prime costs include:

- a) **direct materials and direct manufacturing labor costs**
- b) direct manufacturing labor and manufacturing overhead costs
- c) direct materials and manufacturing overhead costs
- d) only direct materials

Answer the following questions using the information below:

The East Company manufactures several different products. Unit costs associated with Product ORD203 are as follows:

Direct materials	\$50
Direct manufacturing labor	8
Variable manufacturing overhead	10
Fixed manufacturing overhead	23
Sales commissions (2% of sales)	5
Administrative salaries	9
Total	\$105

18) What are the inventoriable costs per unit associated with Product ORD203?

- a) \$60
- b) \$66
- c) \$48
- d) **\$91**

ضياء الدين صبح

19) What are the period costs per unit associated with Product ORD203?

- a) **\$14**
- b) \$5
- c) \$9
- d) \$26

20) What are the variable costs per unit associated with Product ORD203?

- a) \$60
- b) \$82
- c) **\$73**
- d) \$105

21) What are the fixed costs per unit associated with Product ORD203?

- a) \$23
- b) **\$32**
- c) \$35
- d) \$44

22) For last year, Wampum Enterprises reported revenues of \$420,000, cost of goods sold of \$108,000, cost of goods manufactured of \$101,000, and total operating costs of \$70,000. Operating income for that year was:

- a) \$319,000
- b) \$312,000
- c) \$249,000
- d) **\$242,000**

23) Wheel and Tire Manufacturing currently produces 1,000 tires per month. The following per unit data apply for sales to regular customers:

Direct materials	\$20
Direct manufacturing labor	3
Variable manufacturing overhead	6
Fixed manufacturing overhead	10
Total manufacturing costs	<u>\$39</u>

The plant has capacity for 3,000 tires and is considering expanding production to 2,000 tires. What is the total cost of producing 2,000 tires?

- a) \$39,000
- b) \$78,000
- c) **\$68,000**
- d) \$62,000

Answer: $[(\$20 + \$3 + \$6) \times 2,000 \text{ units}] + (\$10 \times 1,000 \text{ units}) = \$68,000$

Answer the following questions using the information below "24+25":

The following information pertains to Alleigh's Mannequins:

Manufacturing costs	\$1,500,000
Units manufactured	30,000
Units sold	29,500 units sold for \$85 per unit
Beginning inventory	0 units

ضياء الدين صبح

24) What is the average manufacturing cost per unit?

- a) **\$50.00**
- b) \$50.85
- c) \$17.65
- d) \$85.00

Answer: $\$1,500,000 / 30,000 = \50.00

25) What is the amount of ending finished goods inventory?

- a) \$42,500
- b) \$25,424
- c) **\$25,000**
- d) \$1,475,000

Answer: $(30,000 - 29,500) \times (\$1,500,000 / \$30,000) = \$25,000$

26) In the cost classification system used by manufacturing firms, total manufacturing costs would include all of the following EXCEPT:

- a) direct materials costs and conversion costs
- b) direct materials costs, direct manufacturing labor costs, and manufacturing overhead costs
- c) **indirect materials costs, indirect manufacturing labor costs, and manufacturing overhead costs**
- d) prime costs and manufacturing overhead costs

27) Which of the following formulas determine cost of goods sold in a merchandising entity?

- a) Beginning inventory + Purchases + Ending inventory = Cost of goods sold
- b) **Beginning inventory + Purchases - Ending inventory = Costs of goods sold**
- c) Beginning inventory - Purchases + Ending inventory = Cost of goods sold
- d) Beginning inventory - Ending inventory - Purchases = Cost of goods sold

28) The following information pertains to the Cannady Corporation:

Beginning work-in-process inventory	\$ 50,000
Ending work-in-process inventory	48,000
Beginning finished goods inventory	180,000
Ending finished goods inventory	195,000
Cost of goods manufactured	1,220,000

What is cost of goods sold?

- a) \$1,235,000
- b) **\$1,205,000**
- c) \$1,218,000
- d) \$1,222,000

Answer the following questions using the information below:

Beginning finished goods, 1/1/20X5	\$ 40,000
Ending finished goods, 12/31/20X5	33,000
Cost of goods sold	250,000
Sales revenue	600,000
Operating expenses	120,000

29) What is cost of goods manufactured for 20X5?

- a) \$257,000
- b) \$350,000
- c) **\$243,000**
- d) \$250,000

Answer: $\$250,000 + \$33,000 - \$40,000 = \$243,000$

ضياء الدين صبح

30) What is gross margin for 20X5?

- a) \$243,000
- b) \$527,000
- c) \$357,000
- d) **\$350,000**

Answer: \$600,000 - \$250,000 = \$350,000

31) What is operating income for 20X5?

- a) **\$230,000**
- b) \$123,000
- c) \$107,000
- d) \$157,000

Answer: \$600,000 - \$250,000 - \$120,000 = \$230,000

Q2: Indicate whether each of the following statements is true or false.

- True 1. Products, services, departments, and customers may be cost objects.
- True 2. Actual costs and historical costs are two different terms referring to the same thing.
- True 3. The same cost may be direct for one cost object and indirect for another cost object.
- True 4. Some fixed costs may be classified as direct manufacturing costs.
- True 5. Fixed costs in total will NOT change in the short run, but may change in the long run.
- False 6. Variable costs per unit vary with the level of production or sales volume.
- True 7. The variable cost per unit of a product should stay the same throughout the relevant range of production
- False 8. When 100,000 units are produced the fixed cost is \$20 per unit. Therefore, when 500,000 units are produced fixed costs will remain at \$20 per unit.
- False 9. Google would be an example of a merchandising company
- True 10. Direct manufacturing labor includes wages and fringe benefits paid to machine operators.

Q3: Renka's Heaters selected data for October 2014 are presented here (in millions):

Direct materials inventory 10/1/2014	\$ 105
Direct materials purchased	365
Direct materials used	385
Total manufacturing overhead costs	450
Variable manufacturing overhead costs	265
Total manufacturing costs incurred during October 2014	1,610
Work-in-process inventory 10/1/2014	230
Cost of goods manufactured	1,660
Finished goods inventory 10/1/2014	130
Cost of goods sold	1,770

Calculate the following costs: احسب التكاليف التالية

1. Direct materials inventory 10/31/2014
2. Fixed manufacturing overhead costs for October 2014
3. Direct manufacturing labor costs for October 2014
4. Work-in-process inventory 10/31/2014
5. Cost of finished goods available for sale in October 2014
6. Finished goods inventory 10/31/2014

Answers:

1. **Ending Balance of DM = 105 + 365 – 385 = 470 – 385 = \$85**

تليخيص CH2 - ACCT335 (COST)

ضياء الدين صبح

2. Fixed MOH = Total MOH – Variable MOH = 450 – 265 = **\$185**
3. Total Manuf.costs = DM used + DL + MOH DL = Total Manuf.Costs – (DM used + MOH)
DL = 1,610 – (385+450) = 1,610 – 835 = **\$775**
4. WIP Ending Balance = Beginning Balance + Total Manuf + C.G.M
= 230 + 1,610 – 1,660 = **\$180**
5. C.G.A.S = F.G + C.G.M = 130 + 1,660 = **\$1,790**
6. F.G Ending Balance = Beginning Balance + C.G.M + C.G.S
= 130 + 1,660 – 1,770 = 1,790 – 1,770 = **\$20**

Q4: Archambeau Products Company manufactures office furniture. Recently, the company decided to develop a formal cost accounting system and classify all costs into three categories. Categorize each of the following items as being appropriate for (1) cost tracing to the finished furniture, (2) cost allocation of an indirect manufacturing cost to the finished furniture, or (3) as a nonmanufacturing item

شركة Archambeau Products تصنع أثاث المكاتب. قررت الشركة مؤخرًا تطوير نظام محاسبية تكاليف رسمي وتصنيف جميع التكاليف إلى ثلاث فئات. صنف كل عنصر من العناصر التالية على أنه مناسب لـ (1) تتبع التكلفة للأثاث الجاهز ، (2) تخصيص تكلفة تكلفة التصنيع غير المباشرة للأثاث الجاهز ، أو (3) كعنصر غير تصنيع

Item	Cost Tracing	Cost Allocation	Nonmanu-facturing	Answer: Item	Cost Tracing	Cost Allocation	Nonmanu-facturing
Carpenter wages	_____	_____	_____	Carpenter wages	X		
Depreciation - office building	_____	_____	_____	Depreciation - office building			X
Glue for assembly	_____	_____	_____	Glue for assembly		X	
Lathe department supervisor	_____	_____	_____	Lathe department supervisor		X	
Lathe depreciation	_____	_____	_____	Lathe depreciation		X	
Lathe maintenance	_____	_____	_____	Lathe maintenance		X	
Lathe operator wages	_____	_____	_____	Lathe operator wages	X		
Lumber	_____	_____	_____	Lumber	X		
Samples for trade shows	_____	_____	_____	Samples for trade shows			X
Metal brackets for drawers	_____	_____	_____	Metal brackets for drawers	X		
Factory washroom supplies	_____	_____	_____	Factory washroom supplies		X	

Q5: ALi manufacturing wants to estimate costs for each product they produce at its ABC plant. The Troy plant produces three products at this plant, and runs two flexible assembly lines. Each assembly line can produce all three products.

س 5: تريد شركة التصنيع علي تقدير تكاليف كل منتج تنتجه في مصنع ABC الخاص بها. ينتج مصنع ABC ثلاثة منتجات في هذا المصنع ، ويدير خطي تجميع مرنين. يمكن لكل خط تجميع إنتاج جميع المنتجات الثلاثة.

المطلوب: Required:

- a. Classify each of the following costs as either direct or indirect for each product.

صنف كل من التكاليف التالية إما مباشرة أو غير مباشرة لكل منتج.

- b. Classify each of the following costs as either fixed or variable with respect to the number of units produced of each product.

صنف كل من التكاليف التالية إما ثابتة أو متغيرة فيما يتعلق بعدد الوحدات المنتجة لكل منتج.

تليخيص (COST) ACCT335 - CH2

ضياء الدين صبح

	<u>Direct</u>	<u>Indirect</u>	<u>Fixed</u>	<u>Variable</u>
Assembly line labor wages	_____	_____	_____	_____
Plant manager's wages	_____	_____	_____	_____
Depreciation on the assembly line equipment	_____	_____	_____	_____
Component parts for the product	_____	_____	_____	_____
Wages of security personnel for the factory	_____	_____	_____	_____

Direct Indirect Fixed Variable

ANSWERS:

Assembly line labor wages		X		X
Plant manager's wages			X	
Depreciation on the assembly line equipment			X	
Component parts for the product	X			X
Wages of security personnel for the factory		X		X

Q6: Hyundai Inc., had the following activities during 2022:

Direct materials:

Beginning inventory	\$ 20,000
Purchases	61,600
Ending inventory	10,400
Direct manufacturing labor	16,000
Manufacturing overhead	12,000
Beginning work-in-process inventory	800
Ending work-in-process inventory	4,000
Beginning finished goods inventory	24,000
Ending finished goods inventory	16,000

المطلوب Required:

- What is the cost of direct materials used during 2022?
ما هي تكلفة المواد المباشرة المستخدمة خلال عام 2022؟
- What is cost of goods manufactured for 2022?
ما هي تكلفة البضائع المصنعة لعام 2022؟
- What is cost of goods sold for 2022?
ما هي تكلفة البضائع المباعة لعام 2022؟
- What amount of prime costs was added to production during 2022?
ما مقدار التكاليف الأولية التي تمت إضافتها إلى الإنتاج خلال عام 2022؟
- What amount of conversion costs was added to production during 2022?
ما مقدار تكاليف التحويل التي تمت إضافتها إلى الإنتاج خلال عام 2022؟

Answers:

- $\$20,000 + \$61,600 - \$10,400 = \$71,200$
- $\$71,200 + \$16,000 + \$12,000 + \$800 - \$4,000 = \$96,000$
- $\$96,000 + \$24,000 - \$16,000 = \$104,000$
- $\$71,200 + \$16,000 = \$87,200$
- $\$16,000 + \$12,000 = \$28,000$

Q7: Using the following information find the unknown amounts. Assume each set of information is an independent case.

باستخدام المعلومات التالية ، ابحث عن المبالغ غير المعروفة. افترض أن كل مجموعة من المعلومات هي ملف حالة مستقلة.

a.	Merchandise Inventory	Purchases	\$210,000
		Cost of goods sold	223,000
		Beginning balance	41,000

ضياء الدين صبح

		Ending balance	????
b.	Direct Materials	Beginning balance	\$ 7,000
		Ending balance	14,000
		Purchases	48,000
		Direct materials used	????
c.	Work-in-process Inventory	Ending balance	\$ 22,000
		Cost of goods manufactured	21,000
		Beginning balance	8,000
		Current manufacturing costs	????
d.	Finished Goods Inventory	Cost of goods manufactured	\$62,000
		Ending balance	20,000
		Cost of goods sold	61,000
		Beginning balance	????

Answers:

a. Ending balance of merchandise inventory: $\$41,000 + \$210,000 - \$223,000 = \underline{\$28,000}$

b. Direct materials used: $\$7,000 + \$48,000 - \$14,000 = \underline{\$41,000}$

c. Current manufacturing costs: $\$21,000 + \$22,000 - \$8,000 = \underline{\$35,000}$

d. Beginning balance of finished goods inventory: $\$20,000 + \$61,000 - \$62,000 = \underline{\$19,000}$

Q8: Each of the following items pertains to one of these companies: Bedell Electronics (a manufacturing company), Gregory Food Retailers (a merchandising company), and Larson Real Estate (a service sector company). Classify each item as either inventoriable (I) costs or period (P) costs.

س 8: كل عنصر من العناصر التالية يخص إحدى هذه الشركات: Bedell Electronics (شركة تصنيع) ، و Gregory Food Retailers (شركة تجارية) ، و Larson Real Estate (شركة قطاع خدمات). قم بتصنيف كل عنصر على أنه إما تكاليف قابلة للجرد (I) أو تكاليف الفترة (P).

		inventoriable (I) costs or period (P) costs
a.	Salary of Bedell Electronics president	P
b.	Depreciation on Bedell Electronics assembly equipment.	I
c.	Salaries of Bedell's assembly line workers	I
d.	Purchase of frozen food for sale to customers by Gregory Food Retailers	I
e.	Salaries of frozen food personnel at Gregory Food Retailing	I
f.	Depreciation on freezers at Gregory Food Retailing	P
g.	Salary of a receptionist at Larson Real Estate	P
h.	Depreciation on a computer at Larson Real Estate	P
i.	Salary of a real estate agent at Larson Real Estate	P

Q9: The following information pertains to Ball Company:

المعلومات التالية تخص شركة

Manufacturing costs \$2,400,000

Units manufactured 40,000

Beginning inventory 0 units

39,800 units are sold during the year for \$100 per unit.

Required: المطلوب

a. What is the average manufacturing cost per unit?

ضياء الدين صبح

- b. What is the amount of ending finished goods inventory?
- c. What is the amount of gross margin?

Answers:

- a. $\$2,400,000 / 40,000 = \60.00
- b. $(40,000 - 39,800) \times \$60 = \$12,000$
- c. $39,800 \times (\$100 - \$60) = \$1,592,000$

END OF CHAPTER 2

CHAPTER 4

JOB COSTING

توظيف التكلفة

CH4 - ACCT335 (COST) تلخيص

ضياء الدين صبح

Basic Costing Terminology مصطلحات التكلفة الأساسية

Let's review several key terms from prior chapters: دعنا نراجع عدة مصطلحات أساسية من التوابير السابقة

- **Cost objects** are anything for which a cost measurement is desired
كائنات التكلفة هي أي شيء مطلوب قياس التكلفة من أجله مثل : سيارة ، إطار سيارة ، علبة كولا ، الخ
- **Direct costs** of a cost object are costs that can be traced to that cost object in an economically feasible way
التكاليف المباشرة لكائن التكلفة هي التكاليف التي يمكن تتبعها إلى كائن التكلفة هذا بطريقة مجدية اقتصاديًا
- **Indirect costs** of a cost object are costs that cannot be traced in an economically feasible way
التكاليف غير المباشرة لكائن التكلفة هي تكاليف لا يمكن تتبعها بطريقة مجدية اقتصاديًا

And Some New Terms وبعض المصطلحات الجديدة

- **Cost Pool** – a grouping of individual indirect cost items. Cost pools simplify the allocation of indirect costs because the costing system does not have to allocate each cost individually.
مجمع التكلفة - تجميع بنود التكلفة غير المباشرة الفردية. تعمل مجموعات التكاليف على تبسيط عملية تخصيص التكاليف غير المباشرة لأن نظام تقدير التكاليف لا يحتاج إلى تخصيص كل تكلفة على حدة.
- **Cost-allocation base** – a systematic way to link an indirect cost or group of indirect costs to cost objects. (For example: direct labor hours).
قاعدة توزيع التكلفة - طريقة منهجية لربط التكلفة غير المباشرة أو مجموعة التكاليف غير المباشرة بأشياء التكلفة. (على سبيل المثال: ساعات العمل المباشرة).
- The concepts represented by these five terms constitute the building blocks we will use to design the costing systems described in this chapter.
تشكل المفاهيم التي تمثلها هذه المصطلحات الخمسة اللبنات الأساسية التي سنستخدمها لتصميم أنظمة تقدير التكاليف الموضحة في هذا التوابير.

Costing Systems نظم التكاليف

1. In a **JOB COSTING SYSTEM**, "سيتم شرحه في هاد التوابير"
نظام تكلفة الوظائف
 - the cost object is a unit or multiple units of a distinct product or service which we call a job.
كائن التكلفة هو وحدة أو وحدات متعددة لمنتج أو خدمة مميزة نسبيًا وظيفية
 - Each job generally uses different amounts of resources.
تستخدم كل وظيفة بشكل عام كميات مختلفة من الموارد.
 - Costs are accumulated separately for each job.
يتم تجميع التكاليف بشكل منفصل لكل وظيفة
 - **Examples: construction Companies, movies production, audit firms, Kellogg (corn flakes, crispix).**
أمثلة: شركات البناء ، إنتاج الأفلام ، شركات التدقيق ، Kellogg (رقائق الذرة ، كريسبيكس).
2. In a **PROCESS COSTING SYSTEM**, "سيتم شرحه في توابير 17"
نظام تكلفة العملية
 - the cost object is masses of identical or similar units of a product or service.
كائن التكلفة هو كتل من وحدات متطابقة أو متشابهة لمنتج أو خدمة.
 - In this type of system, we divide the total cost of producing an identical or similar product or service by the total number of units produced to obtain a per-unit cost.
في هذا النوع من الأنظمة ، نقسم التكلفة الإجمالية لإنتاج منتج أو خدمة متطابقة أو متشابهة على العدد الإجمالي للوحدات المنتجة للحصول على تكلفة كل وحدة.
 - **Examples: Pepsi Co., Corn flakes production by Kellogg.**
أمثلة: شركة بيبسي ، إنتاج رقائق الذرة من شركة كيلوج.

JOURNAL ENTRIES إدخالات دفتر اليومية

TRANSACTION 1: \$80,000 worth of materials (direct and indirect) were purchased on credit.

المعاملة 1: تم شراء مواد بقيمة 80000 دولار (مباشرة وغير مباشرة) على الحساب "على الدين".

Dr. Materials inventory 80,000

Cr. Accounts Payable 80,000

Materials Inventory

\$80,000

CH4 - ACCT335 (COST) تلخيص

ضياء الدين صبح

TRANSACTION 2: Materials costing \$75,000 were sent to the manufacturing plant floor. \$50,000 were issued to Job No. 650 and \$10,000 to Job 651. \$15,000 of indirect materials were issued.

المعاملة 2: تم إرسال مواد بتكلفة 75000 دولار إلى أرضية المصنع. تم إصدار 50000 دولار للوظيفة رقم 650 و 10000 دولار للوظيفة 651. تم إصدار 15000 دولار من المواد غير المباشرة.

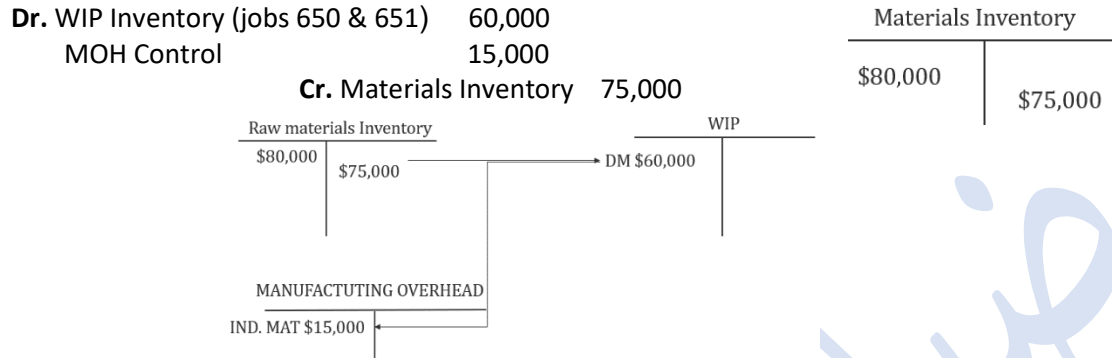

TRANSACTION 3: Total manufacturing payroll for the period was \$27,000. Job No. 650 incurred direct labor costs of \$19,000 and Job No. 651 incurred direct labor costs of \$3,000. \$5,000 of indirect labor was also incurred

المعاملة 3: إجمالي رواتب التصنيع لهذه الفترة كان 27000 دولار. تكبدت الوظيفة رقم 650 تكاليف عمالة مباشرة قدرها 19000 دولار وتكبدت الوظيفة رقم 651 تكاليف عمالة مباشرة قدرها 3000 دولار. كما تم تكبد 5000 دولار من العمالة غير المباشرة

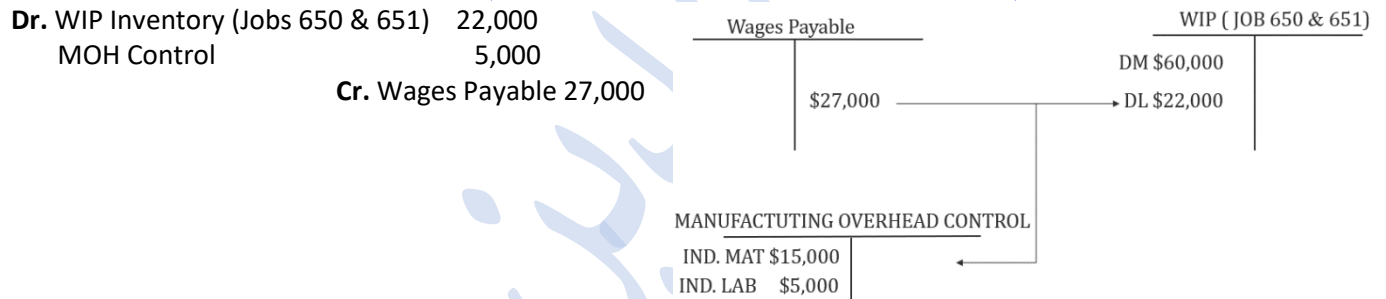

TRANSACTION 4: Assume that machine depreciation for the period is \$26,000. Other manufacturing overhead incurred amounted to \$33,100

المعاملة 4: افترض أن إستهلاك الآلة للفترة هو 26000 دولار. وبلغت النفقات العامة التصنيعية الأخرى المتكبدة 33100 دولار

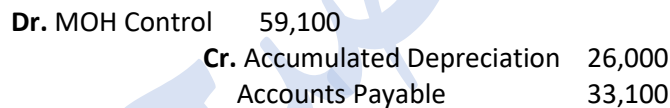

Allocation of Indirect costs تخصيص التكاليف غير المباشرة

NORMAL COSTING – allocates indirect costs based on the **budgeted** indirect cost rates times the **actual** quantities of the cost allocation base.

التكلفة العادية - تخصص التكاليف غير المباشرة بناءً على معدلات التكلفة غير المباشرة المتوقعة مضروباً في الكميات الفعلية لقاعدة تخصيص التكلفة.

First: Compute the Rate per Unit of each cost-allocation base used to allocate indirect costs to the job

أولاً: حساب المعدل لكل وحدة لكل قاعدة توزيع تكلفة مستخدمة لتخصيص التكاليف غير المباشرة للوظيفة

$$\text{Budgeted Manufacturing Overhad Rate} = \frac{\text{Budgeted Manufacturing Overhad Costs}}{\text{Budgeted Total Quantity Of Cost - Allocation Base}}$$

Second: Compute the indirect costs allocated to the job: ثانياً: احتساب التكاليف غير المباشرة المخصصة للوظيفة

$$\text{Budgeted MOH Allocation Rate} \times \text{Actual Base Activity for the Job}$$

CH4 - ACCT335 (COST) تلخيص

ضياء الدين صبح

Ex: Assume that the manufacturing company budgets \$60,000 for total manufacturing overhead costs and 2,400 machine-hours (the allocation base). What is the budgeted indirect-cost rate?

على سبيل المثال: افترض أن الشركة المصنعة تضع ميزانية قدرها 60 ألف دولار لإجمالي تكاليف التصنيع العامة و 2400 ساعة عمل للماكينة (أساس التخصيص). ما هو معدل التكلفة غير المباشرة المتوقعة؟

$$\text{Budgeted Manufacturing Overhad Rate} = \frac{\text{Budgeted Total Quantity Of Cost} - \text{Allocation Base}}{\$60,000}$$

$$\text{Budgeted Manufacturing Overhad Rate} = \frac{\$60,000}{2400 \text{ Machine Hours}} = \$25 / \text{Machine Hours}$$

Ex: How much indirect cost should be allocated to Jobs 650 and 651 assuming they incurred 1000 and 1980 machine hours respectively?

على سبيل المثال: ما مقدار التكلفة غير المباشرة التي يجب تخصيصها للوظائف 650 و 651 بافتراض أنهما تكبدتا 1000 و 1980 ساعة آلة على التوالي؟ (يجب الاعتماد على الأرقام في المثال السابق)

MOH Allocated to Job 650 = **Budgeted MOH Allocation Rate x Actual Base Activity for the Job**

$$\$25/ \text{ machine h.} \quad \times \quad 1,000 \text{ machine hours} \quad = \underline{\$ 25,000}$$

MOH Allocated to Job 651 = **Budgeted MOH Allocation Rate x Actual Base Activity for the Job**

$$\$25/ \text{ machine h.} \quad \times \quad 1980 \text{ machine hours} \quad = \underline{\$49,500}$$

Total MOH Allocated = \$25,000 + \$49,500 = \$74,500

What journal entry should be recorded?

Dr. WIP Inventory (Jobs 650 & 651) 74,500

Cr. MOH Allocated 74,500

WIP	
DM	\$60,000
DL	\$22,000
MOH ALLOC.	\$ 74,500
	<u>\$156,500</u>

Assume Job 650 is completed and sold for \$150,000 on account, what are the required journal entries?

افترض أن العمل 650 قد اكتمل وبيع مقابل 150 ألف دولار على الحساب ، ما هي إدخالات دفتر اليومية المطلوبة؟

Total Cost of Job 650 "مجموع تكاليف العمل 650 من خلال الرجوع الى الأمثلة السابقة"

DM \$50,000

DL 19,000

MOH Allocated 25,000

Total Manufacturing costs of Job 650 \$94,000

First: Dr. Finished goods Inventory (Job 650) 94,000

Cr. WIP Inventory (Job 650) 94,000

Second: Dr. C.G.S 94,000

Cr. Finished goods Inventory 94,000

Dr. Accounts Receivable \$150,000

Cr. Sales \$150,000

Accounting for Overhead محاسبة النفقات العامة

Recall that two different overhead accounts were used in the preceding journal entries:

تذكر أنه تم استخدام حسابين عاميين مختلفين في إدخالات دفتر اليومية السابقة:

- Manufacturing overhead **control** was debited for the actual overhead costs incurred.
تم خصم التحكم في نفقات التصنيع للتكاليف الفعلية المتكبدة.
- Manufacturing overhead **allocated** was credited for estimated (budgeted) overhead applied to production through the work-in-process account.

تم إضافة النفقات العامة للتصنيع المخصصة للتكاليف التقديرية (المدرجة في الميزانية) المطبقة على الإنتاج من خلال حساب العمل قيد التشغيل.

CH4 - ACCT335 (COST) تلخيص

ضياء الدين صبح

BACK TO MOH and MOH ALLOCATED

MOH Control	MOH ALLOCATED
\$79,100	\$74,500
	
Difference = \$4,600	

Actual costs will almost never equal budgeted costs. Accordingly, an imbalance situation exists between the two overhead accounts.

التكاليف الفعلية لن تساوي أبدًا التكاليف المتوقعة . وفقًا لذلك ، يوجد حالة عدم توازن بين الحسابين العاميين.

- If Overhead Control > Overhead Allocated, this is called **UNDERALLOCATED** overhead في حالة التحكم في النفقات العامة < تخصيص النفقات العامة ، يُطلق على ذلك اسم **النفقات العامة غير المخصصة**
- If Overhead Control < Overhead Allocated, this is called **OVERALLOCATED** overhead. إذا كان التحكم في النفقات العامة > تخصيص النفقات العامة ، يسمى هذا **الحمل الزائد**.

The difference between the overhead accounts will be eliminated in the end-of-period adjusting entry process, using one of two possible methods.

سيتم التخلص من الفرق بين الحسابات العامة في عملية تعديل إدخال نهاية الفترة ، باستخدام إحدى الطريقتين المحتملتين.

1. **Proration approach:** the difference is allocated between cost of goods sold, work-in-process, and finished goods based on their relative sizes. **نهج التقسيم:** يتم توزيع الفرق بين تكلفة البضائع المباعة والعمل قيد التشغيل والسلع التامة الصنع بناءً على أحجامها النسبية.
2. **Write-off approach:** the difference is simply written off to cost of goods sold **نهج الشطب:** يتم ببساطة حذف الفرق من تكلفة البضائع المباعة

Ex: When the WIP \$62,500 and C.G.S \$94,000 and No Finished Good, Make a journal entry with:

1. Proration approach
2. Write-off approach

Answer:

1. **WIP inventory** = (WIP / (WIP + F.G + C.G.S) X the difference)
= (\$62,500 / (\$62,500 + 0 + \$94,000) X 4600) = **\$1,837**
C.G.S = (C.G.S / (WIP + F.G + C.G.S) X the difference)
= (\$94,000 / (\$62,500 + 0 + \$94,000) X 4600) = **\$2,763**

Dr. MOH Allocated	74,500	
WIP Inventory	1,837	
C.G.S	2,763	
	Cr. MOH Control	79,100

2. **Dr. MOH Allocated** 74,500
C.G.S. 4,600
Cr. MOH Control 79,100

"السؤال الموجود في السلايد - تم حله في الأسئلة الإضافية (السؤال 3) "

الأسئلة الإضافية Additional Question

Q1: Circle the correct answer

1. Job costing information is used:
 - a. to develop strategies
 - b. to make pricing decisions
 - c. for external financial reporting
 - d. All of these answers are correct.**
2. A _____ is a grouping of individual indirect cost items.
 - a) cost allocation base
 - b) cost assignment
 - c) cost pool**
 - d) job-costing system
3. Each indirect-cost pool of a manufacturing firm:
 - a. utilizes a separate cost-allocation rate
 - b. is a subset of total indirect costs
 - c. relates to one cost object
 - d. All of these answers are correct.**
4. Direct costs
 - a. are anything for which a measurement of costs is desired.
 - b. are costs related to a particular cost object that can be traced to that cost object in an economically feasible (cost-effective) way**
 - c. focus specifically on the costing needs of the CFO
 - d. provide all information for management decision needs
5. Assigning direct costs to a cost object is called:
 - a. cost allocation
 - b. cost assignment
 - c. cost pooling
 - d. cost tracing**
6. _____ is the process of distributing indirect costs to products.
 - a. Cost allocation**
 - b. Job cost recording
 - c. Cost pooling
 - d. Cost tracing
7. A _____ links an indirect cost to a cost object.
 - a. cost-allocation base**
 - b. cost pool
 - c. cost assignment
 - d. cost tracing
8. _____ costing is used by a business to price homogeneous products.
 - a. Actual
 - b. Job
 - c. Process**
 - d. Traditional

ضياء الدين صبح

9. _____ costing is used by a business to price unique products for different jobs.
- Actual
 - Job**
 - Process
 - Traditional
10. Job-costing may only be used by:
- service companies
 - merchandising companies
 - manufacturing companies
 - All of these may use job-costing.**
11. The actual indirect-cost rate is calculated by
- dividing actual total indirect costs by the actual total quantity of the cost-allocation base.**
 - multiplying actual total indirect costs by the actual total quantity of the cost-allocation base.
 - dividing the actual total quantity of the cost allocation base by actual total indirect costs.
 - multiplying the actual total quantity of the cost allocation base by actual total indirect costs.
12. For a given job the direct costs associated with the job are:
- actual overhead
 - direct material
 - direct manufacturing labor
 - Both b and c are correct.**
13. The budgeted indirect-cost rate for each cost pool is computed as
- budgeted annual indirect costs divided by budgeted annual quantity of cost allocation base.**
 - budgeted annual quantity of cost allocation base divided by budgeted annual indirect costs.
 - actual annual indirect costs divided by budgeted annual quantity of cost allocation base.
 - budgeted annual indirect costs divided by budgeted actual quantity of cost allocation base.
14. Stewart Company's actual manufacturing overhead is \$2,800,000. Overhead is allocated on the basis of direct labor hours. The direct labor hours were 50,000 for the period. What is the manufacturing overhead rate?
- \$47.00
 - \$56.00**
 - \$75.00
 - None of the above are correct.
- Explanation:** B) $2,800,000/50,000 = 56.00$
15. O'Reilly Enterprises manufactures digital video equipment. For each unit \$2,950 of direct material is used and there is \$2,000 of direct manufacturing labor at \$20 per hour. Manufacturing overhead is applied at \$35 per direct manufacturing labor hour. Calculate the cost of each unit.
- \$4,950
 - \$9,950
 - \$8,450**
 - \$11,950
- Explanation:** C) $2,950+2,000+((2,000/20) *35)$
16. In a job-costing system, a manufacturing firm typically uses an indirect-cost rate to estimate the _____ allocated to a job.
- | | |
|--|-----------------|
| A) direct materials | B) direct labor |
| C) manufacturing overhead costs | D) total costs |

ضياء الدين صبح

Answer the following questions using the information below:

For 2010, Jake's Dog Supply Manufacturing uses machine-hours as the only overhead cost-allocation base. The accounting records contain the following information:

	<u>Estimated</u>	<u>Actual</u>
Manufacturing overhead costs	\$200,000	\$240,000
Machine-hours	40,000	50,000

17. Using job costing, the 2010 actual indirect-cost rate is:

- a. \$4.00 per machine-hour
- b. \$4.80 per machine-hour**
- c. \$5.00 per machine-hour
- d. \$6.00 per machine-hour

Explanation: B) $\$240,000 / 50,000 \text{ mh} = \4.80

18. Using actual costing, the amount of manufacturing overhead costs allocated to jobs during 2010 is:

- a. \$300,000
- b. \$250,000
- c. \$240,000.**
- d. \$200,000

Explanation: C) $50,000 \text{ mh} \times \$240,000 / 50,000 \text{ mh allocation rate} = \$240,000$

Answer the following questions using the information below:

Philadelphia Company manufactures pipes and applies manufacturing overhead costs to production at a budgeted indirect-cost rate of \$15 per direct labor-hour. The following data are obtained from the accounting records for June 2010:

Direct materials	\$140,000
Direct labor (3,500 hours @ \$11/hour)	\$ 38,500
Indirect labor	\$ 10,000
Plant facility rent	\$ 30,000
Depreciation on plant machinery and equipment	\$ 15,000
Sales commissions	\$ 20,000
Administrative expenses	\$ 25,000

19. The actual amount of manufacturing overhead costs incurred in June 2010 totals:

- a. \$278,500
- b. \$100,000
- c. \$55,000**
- d. \$40,000

Explanation: C) $\$10,000 + \$30,000 + \$15,000 = \$55,000$

20. The difference between actual costing and normal costing is:

- a. normal costing uses actual quantities of direct-costs
- b. actual costing uses actual quantities of direct-costs
- c. normal costing uses budgeted indirect-costs**
- d. actual costing uses actual quantities of cost-allocation bases

21. When using a normal costing system, manufacturing overhead is allocated using the _____ manufacturing overhead rate and the _____ quantity of the allocation base.

- A) budgeted; actual**
- B) budgeted; budgeted
- C) actual; budgeted
- D) actual; actual

ضياء الدين صبح

Answer the following questions using the information below:

For 2010, Jake's Dog Supply Manufacturing uses machine-hours as the only overhead cost-allocation base. The accounting records contain the following information:

	<u>Estimated</u>	<u>Actual</u>
Manufacturing overhead costs	\$200,000	\$240,000
Machine-hours	40,000	50,000

22. Using job costing, the 2010 budgeted manufacturing overhead rate is:

- a. \$4.00 per machine-hour
- b. \$4.80 per machine-hour
- c. \$5.00 per machine-hour**
- d. \$6.00 per machine-hour

Explanation: C) $\$200,000 / 40,000 \text{ mh} = \5

23. Using normal costing, the amount of manufacturing overhead costs allocated to jobs during 2010 is:

- a. \$300,000
- b. \$250,000**
- c. \$240,000
- d. \$200,000

Explanation: B) $50,000 \text{ mh} \times \$200,000 / 40,000 \text{ mh allocation rate} = \$250,000$

24. In a normal costing system, the Manufacturing Overhead Control account:

- a. is increased by allocated manufacturing overhead
- b. is credited with amounts transferred to Work-in-Process
- c. is decreased by allocated manufacturing overhead
- d. is debited with actual overhead costs**

25. The Materials Control account is increased when:

- a. direct materials are purchased
- b. indirect materials are purchased
- c. materials are requisitioned for production
- d. Both A and B are correct.**

26. When direct materials are requisitioned the _____ account is increased.

- a. Manufacturing Overhead Control
- b. Work-in-Process Control**
- c. Materials Control
- d. Accounts Payable Control

27. What is the appropriate journal entry if \$100,000 of materials were purchased on account for the month of August?

- a. Materials Control 100,000**
Accounts Payable Control 100,000
- b. Work-in-Process Control 100,000
 Accounts Payable Control 100,000
- c. Manufacturing Overhead Control 100,000
 Accounts Receivable Control 100,000
- d. Manufacturing Allocated 100,000
 Accounts Receivable Control 100,000

ضياء الدين صبح

28. All of the following items are debited to Work-in-Process EXCEPT:

- a. allocated manufacturing overhead
- b. completed goods being transferred out of the plant**
- c. direct labor consumed
- d. direct materials consumed

29. Manufacturing overhead costs incurred for the month are:

Utilities	\$30,000
Depreciation on equipment	\$25,000
Repairs	\$20,000

Which is the correct journal entry assuming utilities and repairs were on account?

- a. Manufacturing Overhead Control 75,000**
 Accounts Payable Control 50,000
 Accumulated Depreciation Control 25,000
- b. Manufacturing Overhead Control 75,000
 Accounts Payable Control 75,000
- c. Manufacturing Overhead Control 75,000
 Accumulated Depreciation Control 75,000
- d. Accumulated Depreciation Control 25,000
 Accounts Payable Control 50,000
 Manufacturing Overhead Control 75,000

30. The approach often used when dealing with small amounts of underallocated or overallocated overhead is the _____ approach.

- a. adjusted allocation-rate
- b. proration
- c. write-off to cost of goods sold**
- d. Both A and B are correct.

31. The spreading of under-allocated or overallocated overhead among ending work-in-process, finished goods, and cost of goods sold is called:

- a. the adjusted allocation rate approach
- b. the proration approaches**
- c. the write-off of cost of goods sold approach
- d. None of these answers are correct.

Answer the following questions using the information below:

Because the Abernathy Company used a budgeted indirect-cost rate for its manufacturing operations, the amount allocated (\$200,000) was different from the actual amount incurred (\$225,000).

Ending balances in the relevant accounts are:

Work-in-Process	\$ 10,000
Finished Goods	20,000
Cost of Goods Sold	170,000

32. What is the journal entry used to write off the difference between allocated and actual overhead directly to cost of goods sold?

- a. Manufacturing Overhead Allocated 200,000**
 Cost of Goods Sold 25,000
 Manufacturing Overhead Control 225,000

ضياء الدين صبح

- b. Manufacturing Overhead Control 200,000
Cost of Goods Sold 25,000
Manufacturing Overhead Allocated 225,000
- c. Manufacturing Overhead Allocated 200,000
Work-in-Process Control 30,000
Cost of Goods Sold 170,000
- d. Manufacturing Overhead Control 225,000
Work-in-Process Control 55,000
Cost of Goods Sold 170,000

33. In the service sector, to achieve timely reporting on the profitability of an engagement, a company will use:

- a. budgeted rates for all direct costs
- b. budgeted rates for indirect costs
- c. actual costing
- d. budgeted rates for some direct costs and indirect costs**

34. The basic source document for direct manufacturing labor is the:

- a. job-cost record
- b. materials-requisition record
- c. labor-time record**
- d. All of these answers are correct.

35. The budgeted indirect-cost rate is calculated:

- a. at the beginning of the year**
- b. during the year
- c. at the end of each quarter
- d. at the end of the year

Q2: Indicate whether each of the following statements is true or false.

- False 1. Direct costs are allocated to the cost object using a cost-allocation method.
- True 2. A cost object is anything for which a measurement of costs is desired.
- True 3. The cost-allocation base is a systematic way to link an indirect cost or group of indirect costs to cost objects.
- True 4. Cost objects may be jobs, products, or customers.
- False 5. Normal costing is a method of job costing that allocates an indirect cost based on the actual indirect cost rate times the actual quantity of the cost-allocation base.
- False 6. In each period, job costing divides the total cost of producing an identical or similar product by the total number of units produced to obtain a per-unit cost.
- False 7. In job costing, only direct costs are used to determine the cost of a job.
- False 8. Each cost pool may have multiple cost allocation bases.
- True 9. The budgeted indirect cost rate is the budgeted indirect costs divided by budgeted quantity of the cost allocation base.
- True 10. For normal costing, even though the budgeted indirect-cost rate is based on estimates, indirect costs are allocated to products based on actual levels of the cost-allocation base.

CH4 - ACCT335 (COST) تلخيص

ضياء الدين صبح

Q3: Job costing, unit cost, ending work in process. Rafael Company produces pipes for concert-quality organs. Each job is unique. In April 2013, it completed all outstanding orders, and then, in May 2013, it worked on only two jobs, M1 and M2:

Rafael Company, May 2013	<u>Job M1</u>	<u>Job M2</u>
Direct Materials	\$78,000	\$51,000
Direct Manufacturing Labor	273,000	208,000

Direct manufacturing labor is paid at the rate of \$26 per hour. Manufacturing overhead costs are allocated at a budgeted rate of \$20 per direct manufacturing labor-hour. Only Job M1 was completed in May. Actual MoH 355,000.

- Calculate the total cost for Job M1.
- 1,100 pipes were produced for Job M1. Calculate the cost per pipe.
- Prepare the journal entry transferring Job M1 to finished goods.
- What is the ending balance in the Work-in-Process Control account?
- Compute the under- or overallocated manufacturing overhead. Dispose of this amount using the following:
 - Write-off method
 - Proration method

1.	Direct manufacturing labor rate per hour	\$26	
	Manufacturing overhead cost allocated per manufacturing labor-hour	\$20	
		Job M1	Job M2
	Direct manufacturing labor costs	\$273,000	\$208,000
	Direct manufacturing labor-hours ($\$273,000 \div \26 ; $\$208,000 \div \26)	10,500	8,000
	Manufacturing overhead cost allocated ($10,500 \times \$20$; $8,000 \times \$20$)	\$210,000	\$160,000
	Job Costs May 2011	Job M1	Job M2
	Direct materials	\$ 78,000	\$ 51,000
	Direct manufacturing labor	273,000	208,000
	Manufacturing overhead allocated	<u>210,000</u>	<u>160,000</u>
	Total costs	<u>\$561,000</u>	<u>\$419,000</u>

- | | |
|--|-------|
| Number of pipes produced for Job M1 | 1,100 |
| Cost per pipe ($\$561,000 \div 1,100$) | \$510 |
- | | |
|-------------------------|---------|
| Finished Goods Control | 561,000 |
| Work-in-Process Control | 561,000 |

4. $DLH = \frac{208,000}{26} = 8,000$

MOH = $8,000 \times 20 = \$160,000$

Ending Balance = $51,000 + 208,000 + 160,000 = \$419,000$

CH4 - ACCT335 (COST) تلخيص

ضياء الدين صبح

5. MOH Allocated = 370,000, MOH Control = 355,000 Difference (Over-Allocated)= 15,000

a. MOH Allocated 370,000
 MOH Control 355,000
 C.G.S 15,000

b. MOH Allocated 370,000
 MOH Control 355,000
 WIP Inventory 6,413
 F.G Inventory 8,587

Share Of WIP = (WIP / (WIP + F.G + C.G.S) X the difference)
 = (419,000 / (419,000 + 561,000 + 0) X 15,000) = **\$6,413**

Share Of F.G = (F.G / (WIP + F.G + C.G.S) X the difference)
 = (561,000 / (419,000 + 561,000 + 0) X 15,000) = **\$8,587**

Q4: In each of the following situations, determine whether job costing or process costing would be more appropriate.

- | | |
|--------------------------------------|---------------------------------------|
| a. A CPA firm | b. An oil refinery |
| c. A custom furniture manufacturer | d. A tire manufacturer |
| e. A textbook publisher | f. A pharmaceutical company |
| g. An advertising agency | h. An architecture firms |
| i. A flour mill | j. A paint manufacturer |
| k. A nursing home | l. A landscaping company |
| m. A cola-drink-concentrate producer | n. A movie studio |
| o. A law firm | p. A commercial aircraft manufacturer |
| q. A management consulting firm | r. A plumbing contractor |
| s. A catering service | t. A paper mill |
| | u. An auto repair shop |

Answer:

- | | |
|--------------------|--------------------|
| a. Job costing | l. Job costing |
| b. Process costing | m. Process costing |
| c. Job costing | n. Job costing |
| d. Process costing | o. Job costing |
| e. Job costing | p. Job costing |
| f. Process costing | q. Job costing |
| g. Job costing | r. Job costing |
| h. Job costing | s. Job costing |
| i. Process costing | t. Process costing |
| j. Process costing | u. Job costing |
| k. Job costing | |

Q5: Gammaro Company uses normal costing. It allocates manufacturing overhead costs using a budgeted rate per machine-hour. The following data are available for 2014:

Budgeted manufacturing overhead costs	\$4,200,000
Budgeted machine-hours	175,000
Actual manufacturing overhead costs	\$4,050,000
Actual machine-hours	170,000

1. Calculate the budgeted manufacturing overhead rate.
2. Calculate the manufacturing overhead allocated during 2014.

ضياء الدين صبح

3. Calculate the amount of under- or overallocated manufacturing overhead. Why do Gammaro's managers need to calculate this amount?

Answer:

$$\begin{aligned} \text{Budgeted manufacturing overhead rate} &= \frac{\text{Budgeted manufacturing overhead}}{\text{Budgeted machine hours}} \\ &= \frac{\$4,200,000}{175,000 \text{ machine-hours}} = \underline{\underline{\$24 \text{ per machine-hour}}} \end{aligned}$$

$$\begin{aligned} \text{2. Manufacturing overhead allocated} &= \text{Actual machine-hours} \times \text{Budgeted manufacturing overhead rate} \\ &= 170,000 \times \$24 = \underline{\underline{\$4,080,000}} \end{aligned}$$

3. Because manufacturing overhead allocated is greater than the actual manufacturing overhead costs, Gammaro calculates **overallocated manufacturing** overhead as follows:

Manufacturing overhead allocated	\$4,080,000
Actual manufacturing overhead costs	<u>4,050,000</u>
Overallocated manufacturing overhead	<u>\$ 30,000</u>

Q6: The Ride-On-Wave Company (ROW) produces a line of non-motorized boats. ROW uses a normal-costing system and allocates manufacturing overhead using direct manufacturing labor cost. The following data are for 2014:

Budgeted manufacturing overhead cost	\$125,000
Budgeted direct manufacturing labor cost	\$250,000
Actual manufacturing overhead cost	\$117,000
Actual direct manufacturing labor cost	\$228,000

Account	Ending balance	2014 direct manufacturing labor cost in ending balance
Work in process	\$ 50,700	\$20,520
Finished goods	245,050	59,280
Cost of goods sold	549,250	148,200

1. Calculate the manufacturing overhead allocation rate.
2. Compute the amount of under- or overallocated manufacturing overhead.
3. Calculate the ending balances in work in process, finished goods, and cost of goods sold if under- or overallocated manufacturing overhead is as follows:
 - a. Written off to cost of goods sold
 - b. Prorated based on ending balances (before proration) in each of the three accounts
 - c. Prorated based on the overhead allocated in 2014 in the ending balances (before proration) in each of the three accounts

$$1. \text{ Budgeted manufacturing overhead rate} = \frac{\text{Budgeted manufacturing overhead cost}}{\text{Budgeted direct manufacturing labor cost}} = \frac{\$125,000}{\$250,000} = 50\% \text{ of direct manufacturing labor cost}$$

$$2. \text{ Overhead allocated} = 50\% \times \text{Actual direct manufacturing labor cost} = 50\% \times \$228,000 = \$114,000$$

CH4 - ACCT335 (COST) تلخيص

ضياء الدين صبح

Underallocated manufacturing overhead	=	Actual manufacturing overhead costs	-	Allocated plant overhead costs
= \$117,000 - \$114,000 = \$3,000				

Under-allocated manufacturing overhead = \$3,000

3a. All under allocated manufacturing overhead is written off to cost of goods sold.

Both work-in-process (WIP) and finished goods inventory remain unchanged.

Account	Dec. 31, 2014 Balance (Before Proration) (1)	Proration of \$3,000 Underallocated Manuf. Overhead (2)	Dec. 31, 2014 Balance (After Proration) (3) = (1) + (2)
WIP	\$ 50,700	\$ 0	\$ 50,700
Finished Goods	245,050	0	245,050
Cost of Goods Sold	<u>549,250</u>	<u>3,000</u>	<u>552,250</u>
Total	<u>\$845,000</u>	<u>\$3,000</u>	<u>\$848,000</u>

3.(b) Under allocated manufacturing overhead prorated based on ending balances:

Account	Dec. 31, 2014 Account Balance (Before Proration) (1)	Account Balance as a Percent of Total (2) = (1) ÷ \$845,000	Proration of \$3,000 Underallocated Manuf. Overhead (3) = (2) × \$3,000	Dec. 31, 2014 Account Balance (After Proration) (4) = (1) + (3)
WIP	\$ 50,700	0.06	0.06 × \$3,000 = \$ 180	\$ 50,880
Finished Goods	245,050	0.29	0.29 × \$3,000 = 870	245,920
Cost of Goods Sold	<u>549,250</u>	<u>0.65</u>	0.65 × \$3,000 = <u>1,950</u>	<u>551,200</u>
Total	<u>\$845,000</u>	<u>1.00</u>	<u>\$3,000</u>	<u>\$848,000</u>

3.(c) Under-allocated manufacturing overhead prorated based on 2014 overhead in ending balances:

Account	Dec. 31, 2014 Account Balance (Before Proration) (1)	Allocated Manuf. Overhead in Dec. 31, 2014 Balance (Before Proration) (2)	Allocated Manuf. Overhead in Dec. 31, 2014 Balance as a Percent of Total (3) = (2) ÷ \$114,000	Proration of \$3,000 Underallocated Manuf. Overhead (4) = (3) × \$3,000	Dec. 31, 2014 Account Balance (After Proration) (5) = (1) + (4)
WIP	\$ 50,700	\$ 10,260	0.09	0.09 × \$3,000 = \$ 270	\$ 50,970
Finished Goods	245,050	29,640	0.26	0.26 × \$3,000 = 780	245,830
Cost of Goods Sold	<u>549,250</u>	<u>74,100</u>	<u>0.65</u>	0.65 × \$3,000 = <u>1,950</u>	<u>551,200</u>
Total	<u>\$845,000</u>	<u>\$114,000</u>	<u>1.00</u>	<u>\$3,000</u>	<u>\$848,000</u>

Overhead allocated = Direct manuf. labor cost × 50% = \$20,520; \$59,280; \$148,200 × 50%

ضياء الدين صبح

Q7: Jordan Company has two departments, X and Y. Overhead is applied based on direct labor cost in Department X and machine-hours in Department Y. The following additional information is available:

Budgeted Amounts	Department X	Department Y
Direct labor cost	\$180,000	\$165,000
Factory overhead	\$225,000	\$180,000
Machine-hours	51,000 mh	40,000 mh

Actual data for Job #10	Department X	Department Y
Direct materials requisitioned	\$10,000	\$16,000
Direct labor cost	\$11,000	\$14,000
Machine-hours	5,000 mh	3,000 mh

Required:

- Compute the budgeted factory overhead rate for Department X.
- Compute the budgeted factory overhead rate for Department Y.
- What is the total overhead cost of Job 10?
- If Job 10 consists of 50 units of product, what is the unit cost of this job?

Answer:

- $\$225,000 / \$180,000 = 125\% \text{ Or } 1.25$
- $\$180,000 / 40,000 \text{ hrs.} = \4.50 per hour
- $(\$11,000 \times 125 \text{ percent}) + (\$4.50 \times 3,000 \text{ hrs.}) = \$27,250$
- $\$10,000 + \$16,000 + \$11,000 + \$14,000 + \$27,250 = \$78,250 / 50 \text{ units} = \$1,565 \text{ per unit}$

Q8: Job-cost records for Boucher Company contained the following data

Job No.	Date Started	Date Finished	Date Sold	Total Cost of Job at June 30
220	May 18	June 12	June 20	\$6,000
221	May 20	June 19	June 21	4,000
222	June 7	July 5	July 12	7,000
223	June 10	June 28	July 1	6,500
224	June 19	July 16	July 25	8,000

Required:

- Compute WIP inventory at June 30.
- Compute finished goods inventory at June 30.
- Compute cost of goods sold for June.

Answer:

- $\$7,000 + \$8,000 = \$15,000$
- $\$6,500$
- $\$6,000 + \$4,000 = \$10,000$

END OF CHAPTER 4

CHAPTER 17

Process Costing

تكلفة العملية

ضياء الدين صبح

توظيف التكلفة أمام تكلفة العملية
Job versus Process Costing

Job-Costing Systems	أنظمة تكاليف الوظائف	Process-Costing Systems	نظم تكلفة العمليات
Distinct, identifiable units of a product or service	وحدات مميزة ومميزة لمنتج أو خدمة	Masses of identical or similar units of a product or service	كتل من وحدات متطابقة أو متشابهة لمنتج أو خدمة
Examples: Custom-made machines, houses	أمثلة: الآلات المصنوعة حسب الطلب والمنازل	Examples: Food, chemical processing	أمثلة: المواد الغذائية والمعالجة الكيميائية

A little more information about job-vs-process-costing: مزيد من المعلومات حول تكلفة الوظيفة مقابل تكلفة العملية

❖ In a job-costing system, individual jobs use different quantities of resources, so it would be incorrect to cost each job at the same average production cost.

في نظام احتساب تكاليف الوظائف ، تستخدم الوظائف الفردية كميات مختلفة من الموارد ، لذلك سيكون من الخطأ أن تكلف كل وظيفة بنفس متوسط تكلفة الإنتاج.

❖ In contrast, when identical or similar units of products or services are mass-produced, process costing is used to calculate an average production cost for all units produced.

في المقابل ، عندما يتم إنتاج وحدات متطابقة أو متشابهة من المنتجات أو الخدمات بكميات كبيرة ، يتم استخدام تكلفة العملية لحساب متوسط تكلفة الإنتاج لجميع الوحدات المنتجة.

فئات تكلفة "تكلفة العمليات" Process-Costing cost categories

Process-costing systems separate costs into cost categories according to when costs are introduced into the process.

تقوم أنظمة تقدير تكلفة العملية بفصل التكاليف إلى فئات تكلفة وفقاً لتاريخ إدخال التكاليف في العملية.

1. Direct materials are usually added at the beginning of the production process, or at the start of work in a subsequent department down the assembly line.

عادة ما يتم إضافة المواد المباشرة في بداية عملية الإنتاج ، أو في بداية العمل في قسم لاحق أسفل خط التجميع.

2. Conversion costs are generally added equally along the production process.

تضاف تكاليف التحويل بشكل عام بالتساوي على طول عملية الإنتاج.

In situations where this is not the case, additional categories of either direct materials or conversion costs would need to be added.

في الحالات التي لا يكون فيها هذا هو الحال ، يجب إضافة فئات إضافية من المواد المباشرة أو تكاليف التحويل.

$$Process\ Costing = \frac{Total\ Cost}{Total\ Units}$$

Conversion costs = Direct Labor + Overhead Manufacturing

تكلفة العملية: ثلاث حالات Process-costing: three cases

Let's look at the process-costing process three ways: دعونا نلقي نظرة على عملية تقدير تكلفة العملية بثلاث طرق

1. No beginning or ending work-in-process inventories. لا توجد قوائم جرد بدء أو إنهاء العمل في العملية

2. No beginning work-in-process inventory and some ending work-in-process inventory.

لا يوجد جرد بدء العمل في العملية وهناك بعض مخزون العمل قيد التشغيل .

3. Both beginning and ending work-in-process inventories are present.

كل من بداية ونهاية قوائم جرد العمل في العملية موجودة.

تكلفة العملية - الحالة 1 Process costing – case 1

When using process costing without any beginning or ending work-in-process inventory, all costs that were introduced to the process during the period will be assigned to the finished units leaving work-in-process inventory at the end of the period.

عند استخدام تكلفة العملية بدون أي بداية أو إنهاء مخزون العمل قيد التشغيل ، سيتم تعيين جميع التكاليف التي تم تقديمها للعملية خلال الفترة إلى الوحدات المنتهية التي تترك مخزون العمل قيد التشغيل في نهاية الفترة.

Ex With Case 1: Pens Production 10,000 units, DM Cost \$5,000, DL Cost \$15,000, MOH Cost \$10,000, what is the Cost/Unit.

إنتاج الأقلام 10000 وحدة ، DM التكلفة 5000 دولار ، DL 15000 دولار ، MOH 10 آلاف دولار ، ما هي التكلفة / الوحدة.

تلخيص (COST) ACCT335 - CH17

ضياء الدين صبح

$$\text{Answer: Process Costing} = \frac{\text{Total Cost}}{\text{Total Units}} = \frac{\$10,000 + \$5,000 + \$15,000}{10,000 \text{ Unit}} = \frac{\$30,000}{10,000} = 3\$/\text{Unit}$$

***The Company To produced 10,000 Units, Of Which 9,000 Units are completed But Remined (1,000 Unit) in the WIP Stage, and the Percentage of completed **60%**, what is the cost/Unit?

$$\text{Answer: Process Costing} = \frac{\text{Total Cost}}{\text{Total Units}} = \frac{\$10,000 + \$5,000 + \$15,000}{9,000 + (1,000 * 60\%) \text{ Unit}} = \frac{\$30,000}{9,600} = 3.125\$/\text{Unit}$$

هون بحل هاي المسألة افتراضيا " شفتنا المنطق في الحل " 1000 وحدة فعليا 600 منهم Equivalent unit وحدة مكافئة

الوحدات المكافئة Equivalent Units

- ž A derived amount of output units that: مقدار مشتق من وحدات الإنتاج التي
 1. Takes the quantity of each input in units completed and in unfinished units of work in process and يأخذ كمية كل مدخلات في الوحدات المكتملة وفي وحدات العمل غير المكتملة قيد المعالجة و
 2. Converts the quantity of input into the amount of completed output units that could be produced with that quantity of input. يحول كمية المدخلات إلى كمية وحدات الإخراج المكتملة التي يمكن إنتاجها بهذه الكمية من المدخلات.
- ž Are calculated separately for each input. (direct materials and conversion cost) تحسب بشكل منفصل لكل مدخل. (المواد المباشرة وتكلفة التحويل)
- ž When calculating equivalent units, focus on quantities and disregard dollar amounts until after the equivalent units are computed. عند حساب الوحدات المعادلة ، ركز على الكميات وتجاهل المبالغ بالدولار حتى بعد حساب الوحدات المكافئة.

We use a five-step process to allocate costs under process-costing:

نستخدم عملية من خمس خطوات لتخصيص التكاليف في إطار عملية تقدير التكاليف " مهمات جدا للحالة 3+2 ":

1. Summarize the flow of physical units of output. لخص تدفق وحدات الإنتاج المادية
2. Compute output in terms of equivalent units. حساب المخرجات من حيث الوحدات المكافئة
3. Summarize total costs to account for. لخص التكاليف الإجمالية التي يجب أخذها في الاعتبار
4. Compute cost per equivalent unit. حساب التكلفة لكل وحدة معادلة
5. Assign total costs to units completed and to units in ending work-in-process. تعيين التكاليف الإجمالية للوحدات المنجزة والوحدات في إنهاء العمل قيد التشغيل.

case 2 (no Beg WIP, some ending wip)

Ex with Case2: Company Started Producing in February (No Beginning), Started **400 Units**, **175** are completed, (400-175=225 End WIP inventory)

- The Conversion Costs are completion **60%**
- Costs **added** during February
 - ☞ Direct materials (DM) \$32,000
 - ☞ Conversion Costs (C.C) \$18,000

الإجابة حسب الخطوات الخمسة بالتسلسل

1. Summarize the flow of physical units of output

Units From Beginning WIP inventory	0 Units
Units Started during February	<u>400 Units</u>
Total Units to Account For	400 Units

Units Completed and Transferred Out	175 Units
Units in Ending WIP inventory	<u>225 Units</u>
Total Units Accounted For	400 Units

Note: The Total Units to Account for **Equal Usually** the Total Units Accounted For

ضياء الدين صبح

2. Compute output in terms of equivalent units

	DM	C.C
Units Completed and transferred Out	175	175
Equivalent Units of Ending WIP inventory	225 (225 * 100%)	135 (225 * 60%)
Total Output in terms of Equivalent Units	400 E. U	310 E. U

E. U =Equivalent Units

3. Summarize total costs to account for

	DM	C.C	Total Cost
Costs Added February	\$32,000	\$18,600	\$50,600
Total Cost to Account for	\$32,000	\$18,600	\$50,600

4. Compute cost per equivalent unit

	DM	C.C
Total Cos to account for (Step 3)	\$32,000	\$18,600
Total output in terms of E.U (Step 2)	÷ 400	÷ 310
Cost / E. U	\$80	\$60

5. Assign total costs to units completed and to units in ending work-in-process

	DM	C.C	Total
Costs Assigned to units completed and Transferred Out	\$14,000 (175*\$80)	\$10,500 (175*\$60)	\$24,500
Costs Assigned to units in Ending WIP inventory	\$18,000 (225*\$80)	\$8,100 (135*\$60)	\$26,100
Total Accounted For	\$32,000	\$18,600	\$50,600

Case 3 (WITH Beg WIP and ending wip)

Two Valuation Methods: طريقتان للتقييم هنا في الحالة الثالثة

1- Weighted Average Method طريقة المتوسط المرجح

2- FIFO Method طريقة الوارد أولاً يخرج أولاً

Method 1: Weighted Average Method

Process costing can be accomplished using the weighted-average method or the FIFO method. We'll look first at weighted-average.

يمكن تحقيق تكلفة العملية باستخدام طريقة المتوسط المرجح أو طريقة FIFO. سننظر أولاً في المتوسط المرجح.

Calculates cost per equivalent unit of all work done to date. (Regardless of the accounting period in which it was done)

تسبب التكلفة لكل وحدة مكافئة لكل العمل المنجز حتى الآن. (بغض النظر عن الفترة المحاسبية التي تم فيها)

Assigns this cost to equivalent units completed and transferred out of the process, and to equivalent units in ending work-in-process inventory.

يخصص هذه التكلفة للوحدات المكافئة التي تم إكمالها ونقلها خارج العملية، وإلى الوحدات المكافئة في إنهاء مخزون العمل قيد التشغيل

The Weighted-average cost is the total of all costs entering the work-in-process account divided by the total equivalent units of work done to date.

متوسط التكلفة المرجح هو إجمالي كل التكاليف التي تدخل حساب العمل قيد التشغيل مقسوماً على إجمالي وحدات العمل المكافئة التي تم إنجازها حتى تاريخه.

The beginning balance of the work-in-process account (work done in a prior period) is blended in with current period costs.

يتم مزج رصيد بداية حساب العمل قيد التشغيل (العمل المنجز في فترة سابقة) مع تكاليف الفترة الحالية.

ضياء الدين صبح

Ex with Case 3 Weighted-average cost

In the March, the company Beginning inventory are 225 Units (With February) " Dm_100% and C.C_60%", the DM Costs \$18,000 and C.C Costs \$8,100. The company Started 275 Units during March and DM Costs \$19,800 and C.C Costs \$16,380, When DM Completion 100% and C.C 50% with March. The Units Completed 400 and Remained in Ending WIP inventory (100 Units), Assume **the Company Use Weighted-average cost Method**

Answer:

1. Summarize the flow of physical units of output

Units From Beginning WIP inventory	225 Units
Units Started during February	<u>275 Units</u>
Total Units to Account For	500 Units
Units Completed and Transferred Out	400 Units
Units in Ending WIP inventory	<u>100 Units</u>
Total Units Accounted For	500 Units

2. Compute output in terms of equivalent units

	DM	C.C
Units Completed and transferred Out	400	400
Equivalent Units of Ending WIP inventory	<u>100</u> (100 * 100%)	<u>50</u> (100 * 50%)
Total Output in terms of Equivalent Units	500 E. U	450 E. U

3. Summarize total costs to account for

	DM	C.C	Total Cost
Costs From Beginning WIP inventory	\$18,000	\$8,100	\$26,100
Costs Added February	<u>\$19,800</u>	<u>\$16,380</u>	<u>\$36,180</u>
Total Cost to Account for	\$37,800	\$24,480	\$62,280

4. Compute cost per equivalent unit

	DM	C.C
Total Cos to account for (Step 3)	\$37,800	\$24,480
Total output in terms of E.U (Step 2)	÷ 500	÷ 450
Cost / E. U	\$75.6	\$54.4

5. Assign total costs to units completed and to units in ending work-in-process

	DM	C.C	Total
Costs Assigned to units completed and Transferred Out	\$30,240 (400*\$75.6)	\$21,760 (400*\$54.4)	\$52,000
Costs Assigned to units in Ending WIP inventory	\$7,560 (100*\$75.6)	\$2,720 (50*\$54.4)	\$10,280
Total Accounted For	\$37,800	\$24,480	\$62,280

نتيجة العملية Result of the Process

Two critical figures arise out of step 5 of the cost allocation process:

ينشأ رقمان مهمان من الخطوة 5 من عملية تخصيص التكلفة:

- The amount of the journal entry transferring the allocated cost of units completed and sent from work-in-process inventory to finished goods inventory

مقدار إدخال دفتر اليومية الذي يحول التكلفة المخصصة للوحدات المكتملة والمرسلة من مخزون العمل قيد التشغيل إلى مخزون البضائع المنتهية

ضياء الدين صبح

2. The ending balance of the work-in-process inventory account that will appear on the balance sheet.
الرصيد الختامي لحساب المخزون قيد التشغيل الذي سيظهر في الميزانية العمومية

الطريقة 2: الوارد أولاً يصرف أولاً (FIFO) Method 2: First-in, First-Out (FIFO)

- ✗ Assigns the cost of the previous accounting period's equivalent units in beginning work-in-process inventory to the first units completed and transferred out of the process.
يُعيّن تكلفة الوحدات المعادلة للفترة المحاسبية السابقة في بداية مخزون العمل قيد التشغيل إلى الوحدات الأولى المكتملة ونقلها خارج العملية.
- ✗ Assigns the cost of equivalent units worked on during the current period first to complete beginning inventory, next to started and completed new units, and finally to units in ending work-in-process inventory.
يعين تكلفة الوحدات المكافئة التي تم العمل عليها خلال الفترة الحالية أولاً لإكمال بداية المخزون ، بجانب الوحدات الجديدة التي تم البدء فيها والمكتملة ، وأخيراً للوحدات في إنهاء مخزون العمل قيد التشغيل.
- ✗ A distinctive feature of FIFO process-costing method is that work done on beginning inventory is kept separate from work done in the current period.
من السمات المميزة لطريقة احتساب تكلفة عملية FIFO أن العمل المنجز في بداية المخزون يظل منفصلاً عن العمل المنجز في الفترة الحالية.
- ✗ There is no blending of costs as we saw with the weighted-average method.
لا يوجد مزج للتكاليف كما رأينا مع طريقة المتوسط المرجح.

Ex with Case 3 FIFO

In the March, the company Beginning inventory are 225 Units (With February) " Dm_100% and C.C_60%", the DM Costs \$18,000 and C.C Costs \$8,100. The company Started 275 Units during March and DM Costs \$19,800 and C.C Costs \$16,380, When DM Completion 100% and C.C 50% with March. The Units Completed 400 and Remined in Ending WIP inventory (100 Units), **Assume the Company Use FIFO**

Method

Answer:

1. Summarize the flow of physical units of output

Units From Beginning WIP inventory	225 Units
Units Started during February	275 Units
Total Units to Account For	500 Units

Units Completed and Transferred Out"400"	
Units From Beginning WIP inventory	225 Unit
Units Started and Completed	175 Unit
Units in Ending WIP inventory	100 Units
Total Units Accounted For	500 Units

2. Compute output in terms of equivalent units

	DM	C.C
Units Completed and transferred Out	(225 * 0%) = 0 Unit	(225 * 40%) = 90 Unit
Units Started and Completed	175	175
Equivalent Units of Ending WIP inventory	100 (100 * 100%)	50 (100 * 50%)
Total Output in terms of Equivalent Units	275 E. U	315 E. U

ملاحظة: هون عنا في اول نقطة الي خلصناهم وترحلو هم 400 (225 و 175 من هاد الشهر) ، الشهر الماضي شهر 2 كان نسبة الانجاز في DM هو 100% فيعني ذلك ان هذا الشهر شهر 3 نسبة الانجاز فيهم هو 0% ، أما C.C كانت نسبة الإنجاز هي عبارة عن 60% فلذلك ضل عنا هون 40% غير منجزه بشهر 2 بنجزها هون بشهر 3

ضياء الدين صبح

3. Summarize total costs to account for

	DM	C.C	Total Cost
Costs From Beginning WIP inventory	\$18,000	\$8,100	\$26,100
Costs Added February	\$19,800	\$16,380	\$36,180
Total Cost to Account for	\$37,800	\$24,480	\$62,280

4. Compute cost per equivalent unit

	DM	C.C
Total Cos to account for (Step 3)	\$19,800	\$16,380
Total output in terms of E.U (Step 2)	÷ 275	÷ 315
Cost / E. U	\$72	\$52

5. Assign total costs to units completed and to units in ending work-in-process

	DM	C.C	Total
Costs From Beginning WIP inventory	\$18,000	\$8,100	\$26,100
Costs Assigned to units completed and Transferred Out	\$0 (0*\$72)	\$4,680 (90*\$52)	\$4,680
Costs Started and Completed	\$12,600 (175*\$72)	\$9,100 (175*\$52)	\$21,700
Costs Assigned to units in Ending WIP inventory	\$7,200 (100*\$72)	\$2,600 (50*\$52)	\$9,800
Total Accounted For	\$37,800	\$24,480	\$62,280

نتيجة العملية (لا تغيير عن المتوسط المرجح) Result of the Process (no change from weighted average)

Two critical figures arise out of step 5 of the cost-allocation process:

ينشأ رقمان مهمان من الخطوة 5 من عملية تخصيص التكلفة:

- The amount of the journal entry transferring the allocated cost of units completed and sent from work-in-process inventory to finished goods inventory.
 مبلغ إدخال دفتر اليومية الذي يحول التكلفة المخصصة للوحدات المكتملة والمرسلة من مخزون العمل قيد التشغيل إلى مخزون البضائع الجاهزة.
- The ending balance of the work-in-process inventory account that will appear on the balance sheet.

2. الرصيد الختامي لحساب المخزون قيد التشغيل الذي سيظهر في الميزانية العمومية.

Comparing weighted-average and FIFO methods

FIFO assumes that all the higher-cost units (from our example) from the previous period in beginning WIP are the first to be completed and transferred out and that ending WIP consists of only the lower-cost current-period units.

تفترض FIFO أن جميع الوحدات الأعلى تكلفة (من مثالنا) من الفترة السابقة في بداية العمل قيد التقدم هي الأولى التي يتم إكمالها ونقلها إلى الخارج وأن إنهاء العمل قيد التقدم يتكون فقط من وحدات الفترة الحالية منخفضة التكلفة.

The weighted-average method smooths out the cost per equivalent unit by assuming that lower-cost units are transferred out and some higher-cost remain in ending WIP.

تعمل طريقة المتوسط المرجح على تسهيل التكلفة لكل وحدة مكافئة بافتراض نقل المزيد من الوحدات منخفضة التكلفة إلى الخارج مع بقاء بعض التكلفة الأعلى في إنهاء العمل قيد التقدم.

Managers use information from process-costing systems to make pricing and product-mix decisions and understand how well a firm's processes are performing.

يستخدم المديرين المعلومات من أنظمة تقدير تكلفة العملية لاتخاذ قرارات التسعير ومزيج المنتجات وفهم مدى جودة أداء عمليات الشركة.

FIFO provides managers with information about changes in the costs per unit from one period to the next.

يوفر FIFO للمديرين معلومات حول التغييرات في التكاليف لكل وحدة من فترة إلى أخرى.

ضياء الدين صبح

- ž In a period of rising prices, the weighted-average method will decrease taxes because cost of goods sold will be higher and operating income lower.
في فترة ارتفاع الأسعار ، ستعمل طريقة المتوسط المرجح على خفض الضرائب لأن تكلفة البضائع المباعة ستكون أعلى والدخل التشغيلي أقل.

الأسئلة الإضافية Additional Question

Q1: Circle the correct answer

1. Costing systems that are used for the costing of like or similar units of products in mass production are called:
 - a. inventory-costing systems
 - b. job-costing systems
 - c. process-costing systems**
 - d. weighted-average costing systems
2. Process costing should be used to assign costs to products when the:
 - a. units produced are similar
 - b. units produced are dissimilar
 - c. calculation of unit costs requires the averaging of unit costs over all units produced
 - d. Either A or C are correct.**
3. Which one of the following statements is true?
 - a. In a job-costing system, individual jobs use different quantities of production resources.
 - b. In a process-costing system each unit uses approximately the same amount of resources.
 - c. An averaging process is used to calculate unit costs in a job-costing system.
 - d. Both A and B are correct.**
4. Conversion costs:
 - a. include all the factors of production
 - b. include direct labor and overhead
 - c. in process costing are usually considered to be added evenly throughout the production process
 - d. Both B and C are correct.**
5. The purpose of the equivalent-unit computation is to:
 - a. convert completed units into the amount of partially completed output units that could be made with that quantity of input
 - b. assist the business in determining the cost assigned to ending inventory and work-in-process inventory.
 - c. convert partially completed units into the amount of completed output units that could be made with that quantity of input
 - d. Both B and C are correct.**
6. In a process-costing system, the calculation of equivalent units is used for calculating:
 - a. the dollar amount of ending inventory
 - b. the dollar amount of the cost of goods sold for the accounting period
 - c. the dollar cost of a particular job
 - d. Both A and B are correct.**
7. In a process-costing system when goods move from department to department, the accounting for such transfers is relatively simple under:

A) standard costing	B) FIFO costing
C) weighted-average costing	D) operations costing

ضياء الدين صبح

8. The weighted-average process-costing method calculates the equivalent units by:
 - a. considering only the work done during the current period
 - b. the units started during the current period minus the units in ending inventory
 - c. the units started during the current period plus the units in ending inventory
 - d. the equivalent units completed during the current period plus the equivalent units in ending inventory**

9. If there was no beginning work in process and no ending work in process under the weighted-average process costing method, the number of equivalent units for direct materials, if direct materials were added at the start of the process, would be:
 - a. equal to the units started or transferred in
 - b. equal to the units completed
 - c. less than the units completed
 - d. Both A and B are correct.**

10. Under the weighted-average method, the stage of completion of beginning work in process:
 - a. is relevant in determining the equivalent units
 - b. must be combined with the work done during the current period to determine the equivalent units
 - c. is irrelevant in determining the equivalent-unit calculation**
 - d. can almost always be determined with a high degree of precision

Answer the following questions using the information below:

The Lumbar Chair Company manufactures a standard recliner. During February, the firm's Assembly Department started production of 150,000 chairs. During the month, the firm completed 170,000 chairs and transferred them to the Finishing Department. The firm ended the month with 20,000 chairs in ending inventory. All direct materials costs are added at the beginning of the production cycle. Weighted-average costing is used by Lumbar.

11. How many chairs were in inventory at the beginning of the month? Conversion costs are incurred uniformly over the production cycle.
 - a. 10,000 chairs
 - b. 20,000 chairs
 - c. 30,000 chairs
 - d. 40,000 chairs**

12. What were the equivalent units for materials for February?
 - a. 190,000 chairs**
 - b. 170,000 chairs
 - c. 160,000 chairs
 - d. 150,000 chairs

13. What were the equivalent units for conversion costs for February if the beginning inventory was 70% complete as to conversion costs and the ending inventory was 40% complete as to conversion costs?
 - a. 178,000**
 - b. 150,000
 - c. 170,000
 - d. 190,000

ضياء الدين صبح

14. Of the 150,000 units Lumbar started during February, how many were finished during the month?
- 150,000
 - 170,000
 - 130,000**
 - 190,000
15. A distinct feature of the FIFO process-costing method is that the:
- work done on beginning inventory before the current period is blended with the work done during the current period in the calculation of equivalent units
 - work done on beginning inventory before the current period is kept separate from the work done during the current period in the calculation of equivalent units**
 - work done on ending inventory is kept separate from the work done during the current period in the calculation of equivalent units and is usually not included in the calculation
 - FIFO process-costing method is only minimally different from the weighted-average process-costing method
16. An assumption of the FIFO process-costing method is that:
- the units in beginning inventory are not necessarily assumed to be completed by the end of the period
 - the units in beginning inventory are assumed to be completed first**
 - ending inventory will always be completed in the next accounting period
 - no calculation of conversion costs is possible
17. Operating income can differ materially between the results for the weighted-average and FIFO methods when:
- direct materials or conversion costs per unit vary significantly from period to period
 - the physical inventory levels of work in process are large relative to the total number of units transferred out
 - Neither of these answers is correct.
 - Both of these answers is correct.**
18. A major advantage of using the FIFO process-costing method is that:
- FIFO makes the unit cost calculations simpler
 - in contrast with the weighted-average method, FIFO is considered GAAP
 - FIFO provides managers with information about changes in the costs per unit from one period to the next**
 - All of these answers are correct.
19. Transferred-in costs are treated as if they are:
- conversion costs added at the beginning of the process
 - costs of beginning inventory added at the beginning of the process
 - direct labor costs added at the beginning of the process
 - a separate direct material added at the beginning of the process**
20. An operation costing system would be applicable to:
- batches of similar products where each batch is a variation of a single design
 - the construction of a bridge
 - a suit-making operation
 - Both A and C are correct.**

Q2: Indicate whether each of the following statements is true or false.

- True 1. Examples of industries that would use process costing include the soft-drink bottling and oil industry.
- True 2. Process-costing systems separate costs into cost categories according to the timing of when costs are introduced into the process.
- False 3. Job-order costing would be most likely used by a firm that produces homogeneous products.
- False 4. The last step in a process-costing system is to compute cost per equivalent unit.
- True 5. In a process-costing system, there is always a separate Work-in-Process account for each different
- True 6. Equivalent units in beginning work in process PLUS equivalent units of work done in the current period MINUS equivalent units completed and transferred out in the current period EQUALS equivalent units in ending work in process.
- False 7. To calculate weighted-average conversion cost per equivalent unit, you multiply total conversion costs to date by total equivalent units of work done to date.
- True 8. Weighted-average cost per equivalent unit is obtained by dividing the sum of costs for beginning work in process plus costs for work done in the current period by total equivalent units of work done to date.
- False 9. Standard costing is NOT possible in a firm that uses process costing.
- True 10. In companies that produce masses of identical or similar units of output and consequently use process-costing systems, it is relatively easy to set standards and use a standard cost as the cost per equivalent unit.

ملاحظة: يرجى الرجوع الى اسئلة فورمات لأهميتهم ، ولن يكون هنالك أسئلة حل " يرجى الرجوع الى فورمات سابقة يفضل + يرجى التأكد من حل الأمثلة بالشكل الصحيح في التثابتر "فهمهم + التطبيق عليهم" "

END OF CHAPTER 17

CHAPTER 18

Accounting for Spoilage under Process and Job Costing

المحاسبة عن التلف تحت
العملية وتكلفة العمل

ضياء الدين صبح

- ✘ **Spoilage**—units of production, whether fully or partially completed, that do not meet the specifications required by customers for good units and that are discarded or sold for reduced prices.
التلف - وحدات الإنتاج ، سواء أكانت مكتملة أو مكتملة جزئياً ، والتي لا تفي بالمواصفات المطلوبة من قبل الزبائن للوحدات الجيدة والتي يتم التخلص منها أو بيعها بأسعار مخفضة.
- ✘ **Rework**—units of production that do not meet the specifications required by customers but that are subsequently repaired and sold as good finished goods.
إعادة العمل - وحدات الإنتاج التي لا تفي بالمواصفات المطلوبة من قبل الزبائن ولكن يتم إصلاحها وبيعها لاحقاً كسلع تامة الصنع جيدة.
- ✘ **Scrap**—residual material that results from manufacturing a product. Scrap has low total sales value compared with the total sales value of the product.
الخردة - المواد المتبقية الناتجة عن تصنيع المنتج. تحتوي الخردة على قيمة مبيعات إجمالية منخفضة مقارنة بإجمالي قيمة مبيعات المنتج
 - Scrap arises as a residual from the manufacturing process and is not a product targeted for manufacture or sale by the firm.
تنشأ الخردة كمخلفات من عملية التصنيع وليست منتجاً مستهدفاً لتصنيعه أو بيعه من قبل الشركة.

المحاسبة عن التلف Accounting for Spoilage

- ✘ A certain amount of spoilage, rework or scrap is inherent in many production processes.
إن قدرًا معينًا من التلف أو إعادة العمل أو الخردة متأصل في العديد من عمليات الإنتاج.
- ✘ Accounting for spoilage aims to determine the magnitude of spoilage costs and to distinguish between costs of normal and abnormal spoilage.
يهدف حساب التلف إلى تحديد حجم تكاليف التلف والتمييز بين تكاليف التلف الطبيعي وغير الطبيعي.
- ✘ To manage, control, and reduce spoilage costs, they should be highlighted, not simply folded into production costs.
لإدارة ومراقبة وتقليل تكاليف التلف ، يجب تسليط الضوء عليها ، وليس مجرد طيها في تكاليف الإنتاج.

نوعان من التلف: Two Types of Spoilage:

1. **Normal spoilage is spoilage inherent in a particular production process that arises even under efficient operating conditions.**
التلف الطبيعي هو تلف متأصل في عملية إنتاج معينة ينشأ حتى في ظل ظروف التشغيل الفعالة.
 - Normal spoilage rates are computed by dividing the units of normal spoilage by total good units completed, not total actual units started in production.
يتم حساب معدلات التلف الطبيعي بقسمة وحدات التلف الطبيعي على إجمالي الوحدات الجيدة المكتملة ، وليس إجمالي الوحدات الفعلية التي بدأت في الإنتاج.
2. **Abnormal spoilage is spoilage that is not inherent in a particular production process and would not arise under efficient operating conditions.**
التلف غير الطبيعي هو التلف غير المتأصل في عملية إنتاج معينة ولا ينشأ في ظل ظروف التشغيل الفعالة.
 - a. Abnormal spoilage is considered avoidable and controllable.
يعتبر التلف غير الطبيعي أمرًا يمكن تجنبه والسيطرة عليه.
 - b. To highlight the effect of abnormal spoilage costs, companies calculate the units of abnormal spoilage and record the cost in the Loss from Abnormal Spoilage account, which appears as a separate line on the income statement.
لتسليط الضوء على تأثير تكاليف التلف غير الطبيعي ، تقوم الشركات بحساب وحدات التلف غير الطبيعي وتسجيل التكلفة في حساب الخسارة من التلف غير الطبيعي ، والذي يظهر كسطر منفصل في بيان الدخل.

Spoilage in Process Costing using weighted average and fifo costing

التلف في تكلفة العملية باستخدام المتوسط المرجح و fifo

- ✘ Units of normal spoilage can be counted or not counted when computing output units (physical or equivalent) in a process costing system.
يمكن حساب وحدات التلف الطبيعي أو عدم احتسابها عند حساب وحدات الإخراج (المادية أو ما يعادلها) في نظام تكلفة العملية.
- ✘ Counting all spoilage is considered preferable and will be used in our examples here.
يعتبر حساب كل التلف أمرًا مفضلًا وسيتم استخدامه في الأمثلة لدينا هنا.

Weighted Average Method

Step 1: Summarize the flow of physical units of output—identify both normal and abnormal spoilage.

Units From Beginning WIP inventory	1,500 Units
Units Started during February	<u>8,500 Units</u>
Total Units to Account For	10,000 Units
Good units Completed and Transferred Out	7,000 Units
Normal spoilage (10% * 7,000)	700 Units
Abnormal spoilage (1000 – 700)	300 Units
Units in Ending WIP inventory	<u>2,000 Units</u>
Total Units Accounted For	10,000Units

Step 2: Compute output in terms of equivalent units. Spoiled units are included in the computation of output units.

	DM	C.C
Good units Completed and Transferred Out	7,000	7,000
Normal spoilage	700	700
Abnormal spoilage	300	300
Units in Ending WIP inventory	2,000	1,000
Total Output in terms of Equivalent Units	10,000 E. U	9,000 E. U

Step 3: Summarize total costs to account for.

	DM	C.C	Total Cost
Costs From Beginning WIP inventory	\$12,000	\$9,000	\$21,000
Costs Added during the month	<u>\$76,500</u>	<u>\$89,100</u>	<u>\$165,600</u>
Total Cost to Account for	\$88,500	\$98,180	\$186,600

Step 4: Compute cost per equivalent unit.

	DM	C.C
Total Cost to account for (Step 3)	\$88,500	\$98,180
Total output in terms of E.U (Step 2)	÷ 10,000	÷ 9,000
Cost / E. U	\$8.85	\$10.9

Step 5: Assign total costs

	DM	C.C	Total
Costs Assigned to good units completed and Transferred Out	\$61,950 (7,000*\$8.85)	\$76,300 (7,000*\$10.9)	\$135,250
Costs Assigned to normal Spoilage (700)	<u>\$6,195 (700*\$8.85)</u>	<u>\$7,630 (700*\$10.9)</u>	<u>\$13,825</u>
Total Cost to Assigned of good units & T.O	\$ 68,145	\$ 86,930	\$152,075
Costs Assigned to Abnormal Spoilage (300)	\$2,655 (300 * \$8.85)	\$3,270 (300 * \$10.9)	\$5,925
Costs Assigned to units in Ending WIP inventory	\$17,700 (2,000*\$8.85)	\$10,900 (1,000*\$10.9)	\$28,600
Total Accounted For	\$88,500	\$101,100	\$189,600

Journal Entries

Finished Goods Inventory		152,075
WIP Inventory		152,075
Loss from Abnormal Spoilage	5,925	
WIP Inventory		5,925

CH18 - ACCT335 (COST) تلخيص

ضياء الدين صبح

نفس السؤال ونفس المعطيات ولكن هون بطريقة FIFO "انتبه!! هذا ليس متواجد في السلايد او الكتاب"

Step 1: Summarize the flow of physical units of output—identify both normal and abnormal spoilage.

Units From Beginning WIP inventory	1,500 Units
Units Started during February	<u>8,500 Units</u>
Total Units to Account For	10,000 Units

Good units Completed and Transferred Out	
From Beginning WIP inventory	1,500 Units
Units Started & completed (7,000 – 1,500)	5,500 Units
Normal spoilage (10% * 7,000)	700 Units
Abnormal spoilage (1000 – 700)	300 Units
Units in Ending WIP inventory	<u>2,000 Units</u>
Total Units Accounted For	10,000Units

Step 2: Compute output in terms of equivalent units. Spoiled units are included in the computation of output units.

	DM	C.C
Equivalent units Completed Beginning inventory as goods units	0 (0 * 1,500)	600 (40%*1,500)
Good units started & completed during month	5,500	5,500
Normal spoilage	700	700
Abnormal spoilage	300	300
Units in Ending WIP inventory	2,000	1,000
Total Output in terms of Equivalent Units	8,500 E. U	8,100 E. U

Step 3: Summarize total costs to account for.

	DM	C.C	Total Cost
Costs From Beginning WIP inventory	\$12,000	\$9,000	\$21,000
Costs Added during the month	<u>\$76,500</u>	<u>\$89,100</u>	<u>\$165,600</u>
Total Cost to Account for	\$88,500	\$98,180	\$186,600

Step 4: Compute cost per equivalent unit.

	DM	C.C
Total Cost during the month (Step 3)	\$76,500	\$89,100
Total output in terms of E.U (Step 2)	÷ 8,500	÷ 8,100
Cost / E. U	\$9	\$11

Step 5: Assign total costs

	DM	C.C	Total
Costs From Beginning WIP inventory	\$12,000	\$9,000	\$21,000
Costs Assigned to Completed Beginning inventory as goods units	\$ 0	\$6,600 (600 * \$11)	\$6,600
Costs Assigned to good units started and Completed during the month	\$49,500 (9 * 5,500)	\$60,500 (11 * 5,500)	\$110,000
Cost before added normal Spoilage	\$61,500	\$76,100	\$137,600
Costs Assigned to normal Spoilage (700)	<u>\$6,300 (700*\$9)</u>	<u>\$7,700 (700*\$11)</u>	<u>\$14,000</u>
Total Cost to Assigned of good units & T.O	\$ 67,800	\$ 83,800	\$151,600

تلخيص (COST) ACCT335 - CH18

ضياء الدين صبح

Costs Assigned to Abnormal Spoilage (300)	\$2,700(300 * \$9)	\$3,300 (300 * \$11)	\$6,000
Costs Assigned to units in Ending WIP inventory	\$18,000 (2,000*\$9)	\$11,000 (1,000*\$11)	\$29,000
Total Accounted For	\$88,500	\$98,100	\$186,600

تكاليف العمل والتلف Job Costing and Spoilage

Job-costing systems generally distinguish between normal spoilage attributable to a specific job from normal spoilage common to all jobs.

تميز أنظمة تقدير تكاليف العمل عمومًا بين التلف الطبيعي المنسوب إلى وظيفة معينة والتلف العادي الشائع في جميع الوظائف.

Job Costing and Accounting for normal Spoilage attributable to a specific job

حساب تكاليف الوظيفة والمحاسبة عن التلف الطبيعي المنسوب إلى وظيفة معينة

When normal spoilage occurs because of the specifications of a particular job, that job bears the cost of the spoilage minus the disposal value of the spoilage.

عندما يحدث التلف الطبيعي بسبب مواصفات وظيفة معينة ، فإن تلك الوظيفة تتحمل تكلفة التلف مطروحًا منها قيمة التخلص من التلف.

Ex: In the Hull Machine Shop, 5 aircraft parts out of a job lot of 50 aircraft parts are spoiled. The costs assigned prior to the inspection point are \$2,000 per part. When the spoilage is detected, the spoiled goods are inventoried at \$600 per part, the net disposal value.

في Hull Machine Shop ، تلفت 5 قطع غيار طائرات من مجموعة مكونة من 50 قطعة طائرة. التكاليف المعينة قبل نقطة الاستقصاء هي 2000 دولار لكل جزء. عندما يتم الكشف عن التلف ، يتم جرد البضائع التالفة بمبلغ 600 دولار لكل جزء ، وهو صافي قيمة التخلص.

Assuming spoilage is attributable to that specific job: بالتفويض إلى تلك الوظيفة المحددة

Materials Inventory (5 units * \$600) 3,000

Work-in-Process Inventory- specific job (5 units * \$600) 3,000

Job Costing and Accounting for normal Spoilage common to all jobs

احتساب تكاليف العمل ومحاسبة التلف الطبيعي الشائع لجميع الوظائف

In some cases, spoilage may be considered a normal characteristic of the production process.

في بعض الحالات ، يمكن اعتبار التلف من الخصائص الطبيعية لعملية الإنتاج.

The spoilage is costed as manufacturing overhead because it is common to all jobs.

يتم احتساب التلف على أنه تكاليف التصنيع العامة لأنه شائع في جميع الوظائف

The budgeted manufacturing overhead rate includes a provision for normal spoilage.

يشمل معدل تكاليف التصنيع العامة المدرجة في الميزانية مخصصًا للتلف العادي.

Back to the previous example, and assuming that spoilage is common to all jobs:

بالعودة إلى المثال السابق ، وبافتراض أن التلف شائع في جميع الوظائف:

Materials Inventory (5 units * \$600) 3,000

Manufacturing Overhead Control (\$10,000 - \$3,000) 7,000

Work-in-Process Inventory (5 units * \$2,000 per unit) 10,000

حساب تكاليف العمل ومحاسبة التلف غير الطبيعي Job Costing and Accounting for abnormal spoilage

If the spoilage is abnormal, the net loss is charged to the Loss from Abnormal Spoilage Account.

إذا كان التلف غير طبيعي ، يتم تحميل الخسارة الصافية على الخسارة من حساب التلف غير الطبيعي.

Abnormal spoilage costs are not included as a part of the cost of good units produced.

لا يتم تضمين تكاليف التلف غير العادية كجزء من تكلفة الوحدات الجيدة المنتجة.

journal entry should be as follows

Materials Inventory 3,000

Loss from Abnormal Spoilage 7,000

Work-in-Process Inventory 10,000

الأسئلة الإضافية Additional Question

Q1: Circle the correct answer

1. Unacceptable units of production that are discarded or sold for reduced prices are referred to as:
 - a. reworked units
 - b. spoilage**
 - c. scrap
 - d. defective units
2. Unacceptable units of production that are subsequently repaired and sold as acceptable finished goods are:
 - a. reworked units**
 - b. spoilage
 - c. scrap
 - d. defective units
3. Material left over when making a product is referred to as:
 - a. reworked units
 - b. spoilage
 - c. scrap**
 - d. defective units
4. Spoilage that is an inherent result of the particular production process and arises under efficient operating conditions is referred to as:
 - a. ordinary spoilage
 - b. normal spoilage**
 - c. abnormal spoilage
 - d. None of these answers is correct.
5. Spoilage that should NOT arise under efficient operating conditions is referred to as:
 - A) ordinary spoilage
 - B) normal spoilage
 - C) abnormal spoilage**
 - D) None of these answers is correct.
6. Costs of abnormal spoilage are usually accounted for as:
 - a. part of the cost of goods sold
 - b. part of the cost of goods manufactured
 - c. a separate line item in the income statement**
 - d. an asset in the balance sheet
7. Normal spoilage should be computed using as the base the:
 - a. total units completed
 - b. total good units completed**
 - c. total actual units started into production
 - d. None of these answers is correct.
8. Companies that attempt to achieve zero defects in the manufacturing process treat spoilage as:
 - a. scrap
 - b. reworked units
 - c. abnormal spoilage**
 - d. normal spoilage

9. Recognition of spoiled units when computing output units:

- highlights the costs of normal spoilage to management
- distorts the accounting data
- focuses management's attention on reducing spoilage
- Both A and C are correct.**

Q2: Indicate whether each of the following statements is true or false.

- True 1. Some amounts of spoilage, rework, or scrap are inherent in many production processes.
- True 2. Rework is finished production that is NOT in accordance with customer desires. The product is redone and sold as finished goods
- False 3. Scrap and rework are considered to be the same thing by managerial accountants.
- True 4. The costs of normal spoilage are typically included as a component of the costs of good units manufactured.
- False 5. Abnormal spoilage is spoilage that should arise under efficient operating conditions
- True 6. Spoilage can be considered either normal or abnormal.
- True 7. Costs of abnormal spoilage are separately accounted for as losses of the period
- False 8. The first step in the five-step procedure for process costing with spoilage is to compute the output in terms of equivalent units
- False 9. Counting spoiled units as part of output units in a process-costing system usually results in a higher cost per unit
- True 10. Spoilage is typically assumed to occur at the stage of completion where inspection takes place.

Q3: Roku Electronics manufactures universal power adapters at its Desert Sands plant. The company provides you with the following information regarding operations for April 2014:

- ž Total power adapters manufactured 10,000
 - ž Adapters rejected as spoiled units 375
 - ž Total manufacturing cost \$400,000
 - ž Assume the spoiled units have no disposal value.
- What is the unit cost of making the 10,000 universal power adapters?
 - What is the total cost of the 375 spoiled units?
 - If the spoilage is considered normal, what is the increase in the unit cost of good adapters manufactured as a result of the spoilage?
 - If the spoilage is considered abnormal, prepare the journal entries for the spoilage incurred.

Solution:

1. The unit cost of making the 10,000 power adapters is:

$$\$400,000 \div 10,000 \text{ units} = \$40 \text{ per unit}$$

2. The total cost of the 375 spoiled units is:

$$\$40 \times 375 \text{ units} = \$15,000$$

ضياء الدين صبح

3. The increase in the per-unit cost of goods sold as a result of the normal spoilage is:
 $\$15,000 \div 9,625 \text{ good units} = \1.56

Unit cost of goods sold for units remaining after the spoilage = $\$40 + \$1.56 = \$41.56$.
 (Or $\$400,000 \div 9,625 = \41.56)

4. The \$15,000 cost for the 375 spoiled units is taken out of manufacturing costs and expensed in the period of the spoilage. The journal entry to record the abnormal spoilage incurred is:

Loss from abnormal spoilage	15,000	
Work-in-process control		15,000

Q5: For each of the following items identify whether it is spoilage, reworked units, or scrap

- _____ a. Defective jeans sold as seconds
- _____ b. Shavings
- _____ c. Edges from plastic moldings
- _____ d. Carpets sold as seconds
- _____ e. Precision tools that are not built successfully to the necessary tolerance, but which can be successfully converted to a saleable product
- _____ f. Rock extracted as a result of mining processing
- _____ g. Complex defective products such as semiconductors

Answer:

- a. spoilage b. scrap c. scrap d. spoilage
- e. spoilage and rework f. scrap g. spoilage (usually too complex to rework)

Q6: Jellyfish Machine Shop is a manufacturer of motorized carts for vacation

resorts. Patrick Cullin, the plant manager of Jellyfish, obtains the following information for Job #10 in August 2014. A total of 46 units were started, and 6 spoiled units were detected and rejected at final inspection, yielding 40 good units. The spoiled units were considered to be normal spoilage. Costs assigned prior to the inspection point are \$1,100 per unit. The current disposal price of the spoiled units is \$235 per unit. When the spoilage is detected, the spoiled goods are inventoried at \$235 per unit.

1. What is the normal spoilage rate?
2. Prepare the journal entries to record the normal spoilage, assuming the following:
 - a. The spoilage is related to a specific job.
 - b. The spoilage is common to all jobs.
 - c. The spoilage is considered to be abnormal spoilage.

Solution:

1. Normal spoilage rate = $\text{Units of normal spoilage} \div \text{Total good units completed}$
 $= 6 \div 40$
 $= 15\%$.

2. Journal entry for spoilage related to a specific job:

Materials Control (spoiled goods at current disposal value) $6 \times \$23$	1,410	
Work-in-Process Control (Job #10)		1,410

b. Journal entry for spoilage common to all jobs:

Materials Control (spoiled goods at current disposal value) $6 \times \$235$	1,410	
Manufacturing Overhead Control (normal spoilage)	5,190	
Work-in-Process Control (Job #10)		6,600

c. Journal entry for abnormal spoilage:

Materials Control (spoiled goods at current disposal value) $6 \times \$235$	1,410
--	-------

Loss from Abnormal Spoilage 6 × \$865	5,190	
Work-in-Process Control (Job #10)		6,600

Q7: Identify the appropriate order of the following steps in the procedure for process costing with spoilage.

- summarize total costs to account for
- assign total costs to units completed, to spoiled units, and to units in ending inventory
- summarize the flow of physical units
- compute output in terms of equivalent units
- compute cost per equivalent unit

Step 1 _____

Step 2 _____

Step 3 _____

Step 4 _____

Step 5 _____

Answer:

Step 1 c. summarize the flow of physical units

Step 2 d. compute output in terms of equivalent units

Step 3 a. summarize total costs to account for

Step 4 e. compute cost per equivalent unit

Step 5 b. assign total costs to units completed, to spoiled units, and to units in ending inventory

END OF CHAPTER 18

CHAPTER 5

Activity-Based Costing

تقدير التكاليف على
أساس النشاط

CH5 - ACCT335 (COST) تلخيص

ضياء الدين صبح

- Recall that plant overhead is applied to production in a rational systematic manner, using some type of averaging. There are a variety of methods to accomplish this goal.
تذكر أن تكاليف المصنع غير المباشرة يتم تطبيقه على الإنتاج بطريقة عقلانية بشكل منهجي ، باستخدام نوع من المتوسط. هناك مجموعة متنوعة من الأساليب لتحقيق هذا الهدف.
- These methods often involve trade-offs between **simplicity and realism**.
غالبًا ما تتضمن هذه الأساليب مقايضات بين البساطة والواقعية.

Simple Methods Can be inaccurate

Complex Methods Usually more accurate

قد تكون الطرق البسيطة غير دقيقة
الطرق المعقدة عادة ما تكون أكثر دقة

Plantwide & Department OVERHEAD CALCULATIONS العمليات الحسابية على مستوى المصنع والقسم

Plantwide Overhead Rate: معدل النفقات العامة على مستوى المصنع

Total Estimated Overhead* / Total Estimated Base** إجمالي النفقات العامة المقدرة / إجمالي القاعدة المقدرة

*Obtain total of all overhead costs to be allocated.

* الحصول على إجمالي جميع التكاليف العامة التي سيتم تخصيصها.

** Determine best "base" – direct labor hours, machine hours, etc.

** تحديد أفضل "قاعدة" - ساعات العمل المباشرة ، وساعات عمل الماكينة ، وما إلى ذلك.

This rate is used to allocate overhead costs to all products.

يستخدم هذا المعدل لتخصيص التكاليف العامة لجميع المنتجات

Dept Overhead Rate: معدل النفقات العامة للقسم

Similar concept except overhead cost pools and selected base is obtained by department.

مفهوم مماثل باستثناء مجتمعات التكاليف العامة ويتم الحصول على القاعدة المختارة من قبل الإدارة.

For our example, let's say we have Department A and Department B with overhead costs of \$300,000 and \$450,000, respectively. We might also use different bases for each department. In our example, we will use DLH for Department A and Machine Hours for Dept B.

لنفترض أن لدينا القسم "أ" والقسم "ب" بتكاليف عامة تبلغ 300000 دولار و 450 ألف دولار، على التوالي. قد نستخدم أيضًا قواعد مختلفة لكل قسم. في مثالنا ، سنستخدم DLH للقسم A وساعات عمل الجهاز للقسم B.

	Dept A	Dept B
O/H	\$300,000	\$450,000
DLH	8,000	7,000
MH	750	1,200

- What is Overhead allocation in Department A and Department B?
- What is single Plantwide Rate?

Solution:

- Overhead allocation in Department A would be \$300,000 / 8000 (DLH) or **\$37.50 per DLH**
Overhead allocation in Department B would be \$450,000 / 1200 (MH) or **\$375.00 per MH**
- Based on DLH: \$750,000 / 15,000 or **\$50.00/DLH**
Based on MH: \$750,000 / 1,950 or **\$384.62/MH**

Broad Averaging المتوسط الأوسع

- Historically, firms produced a limited variety of goods and at the same time, their indirect costs were relatively small.
تاريخياً ، أنتجت الشركات مجموعة محدودة من السلع ، وفي الوقت نفسه ، كانت تكاليفها غير المباشرة صغيرة نسبياً.
- Allocating overhead costs was simple: use broad averages to allocate costs uniformly regardless of how they are actually incurred.

كان تخصيص التكاليف العامة أمرًا بسيطاً: استخدم متوسطات واسعة لتوزيع التكاليف بشكل موحد بغض النظر عن كيفية تكبدها بالفعل.

- Generally known as "**Peanut-butter costing**" (perhaps because it is spread evenly??)

يُعرف عموماً باسم "تكلفة زبدة الفول السوداني" (ربما لأنه يتم توزيعها بالتساوي؟؟)

CH5 - ACCT335 (COST) تلخيص

ضياء الدين صبح

☒ The end-result: النتيجة النهائية

- Products using fewer resources are over-costed and products using more resources are under-costed.

المنتجات التي تستخدم موارد أقل تكون باهظة الثمن والمنتجات التي تستخدم المزيد من الموارد أقل تكلفة.

- ☒ **Overcosting**—a product consumes a low level of resources but is allocated high costs per unit.
التكلفة الزائدة - يستهلك المنتج مستوى منخفضًا من الموارد ولكن يتم تخصيص تكاليف عالية لكل وحدة.
- ☒ **Undercosting**—a product consumes a high level of resources but is allocated low costs per unit.
خفض التكلفة - يستهلك المنتج مستوى مرتفعًا من الموارد ولكن يتم تخصيص تكاليف منخفضة لكل وحدة.

Ex: What is the Overcosted and Undercosted?

	Rami	Sawsan	Maher	Rana	Total	Average
Entree	\$11	\$20	\$15	\$14	\$60	\$15
Dessert	0	8	4	4	16	4
Drinks	4	24	8	6	32	8
Total	\$15	\$42	\$27	\$24	\$108	\$27

Solution: Overcosted: Rami and Rana & Undercosted: Sawsan

Cross-subsidization الدعم المتبادل

- ☒ If one product is undercosted then at least one other product must be overcosted.
إذا كان أحد المنتجات غير مكلف ، فيجب زيادة تكلفة منتج آخر على الأقل
- ☒ The overcosted product absorbs too much cost, making it seem less profitable than it really is.
يمتص المنتج ذو التكلفة الزائدة الكثير من التكلفة ، مما يجعله يبدو أقل ربحية مما هو عليه بالفعل.
- ☒ The undercosted product is left with too little cost, making it seem more profitable than it really is.
يتم ترك المنتج منخفض التكلفة بتكلفة قليلة جدًا ، مما يجعله يبدو أكثر ربحية مما هو عليه بالفعل.

Ex in page 1 تكلمة على مثال الى في الصفحة الاولى

Let's say that Job 457 for Product XYZ incurs 1000 DLH in Dept A and 1000 DLH in Dept B; 50 MH in Dept A and 75 MH in Dept B.

لنفترض أن العمل 457 للمنتج XYZ تتكبد 1000 DLH في القسم أ و 1000 DLH في القسم ب ؛ 50 MH في القسم A و 75 MH في القسم B.

Overhead would be as follows for this job:

	Dept A/DLH	Dept B/MH	Total Departmental	Single P/W Rate
Departmental Rate:				
	(1000 * 37.5) \$37,500	(75 * 375.00) \$28,125	\$65,625	
Plantwide Rate based on DLH:				(2000 * \$50.00) \$100,000
Plantwide Rate based on MH:				(125 * \$384.62) \$48,077.50

Ex of Company Plastim simple (traditionally)

Data:

- The Quantity 60,000 S3 lenses and Quantity 15,000 CL5 lenses
- The DM 1,125,000 & \$675,000 and DL \$600,000 & \$195,000 of S3 and CL5, **respectively.**
- The indirect costs allocated 1,800,000 and \$585,000 of S3 and CL5, **respectively.**
- Plastim has elected to use Direct Manufacturing Labor Hours as the base and estimates 39,750 such hours
- Our managers have indicated that the DLH budget for the 60,000 S3 lenses is 30,000 hours and 9,750 hours for the 15,000 CL5 lenses, **Compute the Indirect Cost Allocated to the Products.**

ضياء الدين صبح

- **Solution:**

	\$60,000		\$15,000		
	Simple lenses (S3)		Complex Lenses (CL5)		
	Total (1)	Per Unit (2) = (1) ÷ 60,000	Total (3)	Per Unit (4) = (3) ÷ 15,000	Total (5) = (1) + (3)
DM	\$1,125,000	\$18.75	\$675,000	\$45.00	\$1,800,000
DL	600,000	10.00	195,000	13.00	795,000
T. DC	1,725,000	28.75	870,000	58.00	2,595,000
IC Allocated	1,800,000	30.00	585,000	39.00	2,385,000
T. Costs	\$3,525,000	\$58.75	\$1,455,000	\$97.00	\$4,980,000

Compute the Rate per Unit of Each Cost-Allocation Base

Budgeted Total Costs in Indirect Cost Pool / Budgeted Total Quantity of the Cost Allocation Base.

\$2,385,000 / 39,750 = **\$60.00 per Direct Mfg Labor Hour**

That will allocate overhead as follows:

S3 = 30,000 * \$60 = **\$1,800,000**

CL5 = 9,750 * \$60 = **\$585,000**

Activity-Based costing, known as ABC. ABC uses activities as the fundamental cost objects.

التكلفة على أساس النشاط ، تعرف باسم ABC. تستخدم ABC الأنشطة ككائنات تكلفة أساسية.

For example, in your indirect cost pool, you may have expenses related to the purchasing department.

Perhaps the purchasing department incurs expenses in relationship to the number of purchase orders

created, or the number of line items received. That determination and the subsequent use of that

“activity” as the cost driver is how ABC refines our cost systems.

على سبيل المثال ، في مجموعة التكاليف غير المباشرة الخاصة بك ، قد يكون لديك نفقات متعلقة بقسم المشتريات. ربما يتكبد قسم المشتريات نفقات تتعلق بعدد أوامر الشراء التي تم إنشاؤها ، أو عدد البنود المستلمة. هذا التحديد والاستخدام اللاحق لهذا "النشاط" كمحرك للتكلفة هو كيفية قيام ABC بتنقيح أنظمة التكلفة لدينا.

Ex of Company Plastim on ABC

Data:

- The Quantity 60,000 S3 lenses and Quantity 15,000 CL5 lenses
- The DM 1,125,000 & \$675,000 and DL \$600,000 & \$195,000 and Direct materials of cleaning 120,000 & 150,000 of S3 and CL5, **respectively**.
- The Total Budgeted Indirect costs of Design \$450,000, Setup of molding machines \$300,000, Machine operations \$637,500, Shipment setup \$81,000, Distribution \$391,500, Administration \$255,000 and Budgeted Quality of cost-allocation Base Design 100 Parts, Setup of molding machines 2,000 hours, Machine operations 12,750, Shipment setup 200, Distribution \$67,500, Administration \$39,750
- The table you can help to Calculate Total Costs of **ABC**

	Simple lenses	Complex lenses
Design	30 hours	70 hours
Setup of molding machines	500 setup hours	1500 setup hours
Machine operations	9,000 M.Hs	3,750 M.Hs
Shipment setup	100 shipments	100 shipments
Distribution	45,000 cubic feet	22,500 cubic feet
Administration	30,000 DLHs	9,750 DLHs

ضياء الدين صبح

- **Solution:**

First: Calculate Avg Activities of indirect cost

	T.B. IC (1)	B.Q.C.A Base (2)	B.I.C Rate (3) = (1) ÷ (2)
Design	\$450,000	100	\$4,500
Setup of molding machines	\$300,000	2,000	\$ 150
Machine operations	\$637,500	12,750	\$ 50
Shipment setup	\$ 81,000	200	\$ 405
Distribution	\$391,500	67,500	\$ 5.80
Administration	\$255,000	39,750	\$6.4151

Second: Calculate T. Cost of ABC

	\$60,000		\$15,000		Total (5) = (1) + (3)
	Simple lenses (S3)		Complex Lenses (CL5)		
	Total (1)	Per Unit (2) = (1) ÷ 60,000	Total (3)	Per Unit (4) = (3) ÷ 15,000	
DM	\$1,125,000	\$18.75	\$675,000	\$45.00	\$1,800,000
DL	600,000	10.00	195,000	13.00	795,000
DM_C	<u>120,000</u>	<u>2.00</u>	<u>150,000</u>	<u>10.00</u>	<u>270,000</u>
T. DC	<u>1,845,000</u>	<u>30.75</u>	<u>1,020,000</u>	<u>68.00</u>	<u>2,865,000</u>
I.C Activities					
Design*	135,000	2.25	315,000	21.00	450,000
Setup. Mm**	75,000	1.25	225,000	15.00	300,000
Machine's. o***	450,000	7.50	187,500	12.50	637,500
Shipment setup*	40,500	0.67	40,500	2.70	81,000
Distribution **	261,000	4.35	130,500	8.70	391,500
Administration***	<u>192,453</u>	<u>3.21</u>	<u>62,547</u>	<u>4.17</u>	<u>255,000</u>
T.I.C allocated	<u>1,153,953</u>	<u>19.23</u>	<u>961,047</u>	<u>64.07</u>	<u>2,115,000</u>
T. Costs	<u>\$2,998,953</u>	<u>\$49.98</u>	<u>\$1,981,047</u>	<u>\$132.07</u>	<u>\$4,980,000</u>

* Design of S3 = 30 * \$4,500 = \$135,000, and Design of CL5= 70 * \$4,500 = 315,000

** Setup of molding machines of S3= 500 * 150 = \$75,000 and of CL5= 1,500 * 150 = 225,000

*** Machine operations of S3 = 9,000 * 50 = 450,000 and of CL5= 3,750 * 50 = \$187,500

* Shipment setup of S3 = 100 * 405 = 40,500 and of CL5= 100 * 405 = 40,500

** Distribution of S3 = 45,000 * 5.80 = 261,000 and of CL5= 22,500 * 5.80 = 130,500

*** Administration of S3 = 30,000 * 6.4151 = 192,453 and of CL5= 9,750 * 6.4151 = 62,547

Simple and ABC Compared مقارنة بين الطريقة البسيطة والمعقدة

Differences= ABC system – Simple Costing

Ex: of total cost of direct cost of simple = \$2,595,000, and total cost of direct cost of ABC system = \$2,865,000. What are the differences?

Solution:

Differences= ABC system – Simple Costing = 2,865,000 – 2,595,000 = \$270,000

تلخيص (COST) ACCT335 - CH5

ضياء الدين صبح

- ž Each method is mathematically correct. كل طريقة صحيحة رياضياً
- ž Each method is acceptable. كل طريقة مقبولة
- ž Each method yields a different cost figure, which will lead to different gross margin calculations which may lead to differences in other decisions such as pricing. ينتج عن كل طريقة رقم تكلفة مختلف ، مما يؤدي إلى حسابات هامش إجمالي مختلفة قد تؤدي إلى اختلافات في القرارات الأخرى مثل التسعير.
- ž Only overhead is involved. Total costs for the entire firm remain the same—they are just allocated differently to the cost objects within the firm. تشارك فقط النفقات العامة. تظل التكاليف الإجمالية للشركة بأكملها كما هي - حيث يتم تخصيصها بشكل مختلف فقط لعناصر التكلفة داخل الشركة.
- ž Selection of the appropriate method and drivers should be based on experience, industry practices, as well as a cost-benefit analysis of each option under consideration. يجب أن يعتمد اختيار الطريقة والدوافع المناسبة على الخبرة وممارسات الصناعة ، فضلاً عن تحليل التكلفة والعائد لكل خيار قيد الدراسة.

ABC vs. Simple Costing Schemes

- ž ABC is generally perceived to produce superior costing figures due to the use of multiple drivers across multiple levels. يُنظر إلى ABC عمومًا على أنها تنتج أرقام تكلفة أعلى بسبب استخدام محركات متعددة عبر مستويات متعددة.
- ž ABC is only as good as the drivers selected, and their actual relationship to costs. Poorly chosen drivers will produce inaccurate costs, even with ABC. ABC جيدة فقط مثل برامج التشغيل المختارة ، وعلاقتها الفعلية بالتكاليف. سوف ينتج عن برامج التشغيل المختارة بشكل سيئ تكاليف غير دقيقة ، حتى مع ABC
- ž **Using ABC does not guarantee more accurate costs!**

استخدام ABC لا يضمن تكاليف أكثر دقة!

الأسئلة الإضافية Additional Question

Q1: Circle the correct answer

1. If products are different, then for costing purposes:
 - a. **an ABC costing system will yield more accurate cost numbers**
 - b. a simple costing system should be used
 - c. a single indirect-cost rate should be used
 - d. none of the above
2. Overcosting a particular product may result in:
 - a. **loss of market share**
 - b. pricing the product too low
 - c. operating efficiencies
 - d. understating total product costs
3. A company produces three products; if one product is overcosted then:
 - a. one product is undercosted
 - b. **one or two products are undercosted**
 - c. two products are undercosted
 - d. no products are undercosted
4. Misleading cost numbers are most likely the result of misallocating:
 - a. direct material costs
 - b. direct manufacturing labor costs
 - c. **indirect costs**
 - d. All of these answers are correct
5. The use of a single indirect-cost rate is more likely to:
 - a. undercost high-volume simple products
 - b. **undercost low-volume complex products**
 - c. undercost lower-priced products
 - d. Both B and C are correct.
6. Uniformly assigning the costs of resources to cost objects when those resources are actually used in a nonuniform way is called:
 - a. overcosting
 - b. undercosting
 - c. **peanut-butter costing**
 - d. department costing
7. Refining a cost system includes:
 - a. classifying as many costs as indirect costs as is feasible
 - b. creating as many cost pools as possible
 - c. **identifying the activities involved in a process**
 - d. seeking a lesser level of detail
8. ABC systems create:
 - A) one large cost pool
 - B) **homogenous activity-related cost pools**
 - C) activity-cost pools with a broad focus
 - D) activity-cost pools containing many direct costs

ضياء الدين صبح

9. ABC systems:

- a. **highlight the different levels of activities**
- b. limit cost drivers to units of output
- c. allocate costs based on the overall level of activity
- d. generally, undercost complex products

10. Traditional cost systems distort product costs because:

- a. they do not know how to identify the appropriate units
- b. competitive pricing is ignored
- c. they emphasize financial accounting requirements
- d. **they apply average support costs to each unit of product**

Answer the following questions using the information below:

Mertens Company provides the following ABC costing information:

Activities	Total Costs	Activity-cost drivers
Account inquiry hours	\$200,000	10,000 hours
Account billing lines	\$140,000	4,000,000 lines
Account verification accounts	\$75,000	40,000 accounts
Correspondence letters	\$ 25,000	4,000 letters
Total costs	\$440,000	

The above activities are used by Departments A and B as follows:

	Department A	Department B
Account inquiry hours	2,000 hours	4,000 hours
Account billing lines	400,000 lines	200,000 lines
Account verification accounts	10,000 accounts	8,000 accounts
Correspondence letters	1,000 letters	1,600 letters

11. How much of the account inquiry cost will be assigned to Department A?

- a. **\$40,000**
- b. \$200,000
- c. \$80,000
- d. None of these answers are correct.

Explanation: A) $(\$200,000 / 10,000) \times 2,000 = \$40,000$

12. How much of the account billing cost will be assigned to Department B?

- a. \$14,000
- b. \$140,000
- c. **\$7,000**
- d. None of these answers are correct.

Explanation: C) $(\$140,000 / 4,000,000) \times 200,000 = \$7,000$

13. How much of account verification costs will be assigned to Department A?

- a. \$15,000
- b. **\$18,750**
- c. \$75,000
- d. \$5,000

Explanation: B) $(\$75,000 / 40,000) \times 10,000 = \$18,750$

ضياء الدين صبح

14. How much of correspondence costs will be assigned to Department B?

- a. \$800
- b. \$6,250
- c. \$25,000
- d. \$10,000**

Explanation: D) $(\$25,000 / 4,000) \times 1,600 = \$10,000$

15. How much of the total costs will be assigned to Department A?

- a. \$79,000**
- b. \$40,000
- c. \$112,000
- d. \$440,000

Explanation: A) $(\$200,000 / 10,000) \times 2,000 = \$40,000 / (\$140,000 / 4,000,000) \times 400,000 = \$14,000$
 $(\$75,000 / 40,000) \times 10,000 = \$18,750 / (\$25,000 / 4,000) \times 1,000 = \$6,250 = \$79,000$

16. How much of the total costs will be assigned to Department B?

- a. \$79,000
- b. \$40,000
- c. \$112,000**
- d. \$440,000

Explanation: C) $(\$200,000 / 10,000) \times 4,000 = \$80,000 / (\$140,000 / 4,000,000) \times 200,000 = \$7,000$
 $(\$75,000 / 40,000) \times 8,000 = \$15,000 / (\$25,000 / 4,000) \times 1,600 = \$10,000 = \$112,000$

17. Dalrymple Company produces a special spray nozzle. The budgeted indirect total cost of inserting the spray nozzle is \$80,000. The budgeted number of nozzles to be inserted is 40,000. What is the budgeted indirect cost allocation rate for this activity?

- a. \$0.50
- b. \$1.00
- c. \$1.50
- d. \$2.00**

Explanation: D) $\$80,000 / 40,000 = \2.00

18. The most likely example of an output unit-level cost is:

- a. general administrative costs
- b. paying suppliers for orders received
- c. engineering costs
- d. machine depreciation**

19. The most likely example of a batch-level cost is:

- a. utility costs
- b. machine repairs
- c. product-designing costs
- d. setup costs**

20. Design costs are an example of:

- a. unit-level costs
- b. batch-level costs
- c. product-sustaining costs**
- d. facility-sustaining costs

ضياء الدين صبح

21. _____ costs support the organization as a whole.
- Unit-level
 - Batch-level
 - Product-sustaining
 - Facility-sustaining**
22. With traditional costing systems, products manufactured in small batches and in small annual volumes may be _____ because batch-related and product-sustaining costs are assigned using unit related drivers.
- overcosted
 - fairly costed
 - undercosted**
 - ignored

Answer the following questions using the information below:

Products S5 and CP8 each are assigned \$100.00 in indirect costs by a traditional costing system. An activity analysis revealed that although production requirements are identical, S5 requires 45 minutes less setup time than CP8.

23. According to an ABC system, CP8 is _____ under the traditional system.
- undercosted**
 - overcosted
 - fairly costed
 - accurately costed
24. According to an ABC system, S5 uses a disproportionately:
- smaller amount of unit-level costs
 - larger amount of unit-level costs
 - smaller amount of batch-level costs**
 - larger amount of batch-level costs
25. ABC systems identify _____ costs used by products.
- a. all** b. short-term fixed c. short-term variable d. long-term fixed

Q2: Indicate whether each of the following statements is true or false.

- False** 1. If companies increase market share in a given product line because their reported costs are less than their actual costs, they will become more profitable in the long run.
- True** 2. A top-selling product might actually result in losses for the company.
- True** 3. Direct costs plus indirect costs equal total costs.
- False** 4. Indirect labor and distribution costs would most likely be in the same activity-cost pool.
- True** 5. The primary costs of an ABC system are the measurements necessary to implement the system.

Q3: For each of the following activities identify an appropriate activity-cost driver.

- machine maintenance
- machine setup
- quality control
- material ordering
- production scheduling
- warehouse expense
- engineering design

Answer: Any one of the listed cost drivers is correct.

Activity			
Machine Maintenance	# Of machines	Machine hours	Actual times for various maintenances of various machines
Machine Setup	# Of setups	Setup hours	Actual times for various setups for various machines
Quality Control	# of inspections	Inspection hours	Actual times for various inspections for various controls
Material Ordering	# of orders	Ordering hours	Actual times for various orders for various materials
Production Scheduling	# of runs	Scheduling hours	Actual times for various runs for various schedules
Warehousing	# of bins, aisles	Picking hours	Actual times for various parts for various warehousing activities
Engineering Design	# of engineers # of designs	Engineering hours	Actual times for various engineering designs

Q4: Rachel's Pet Supply Corporation manufactures two models of grooming stations, a standard and a deluxe model. The following activity and cost information has been compiled:

Product	Number of Setups	Number of Components	Number of Direct Labor Hours
Standard	3	30	650
Deluxe	7	50	150
Overhead costs	\$40,000	\$120,000	

Assume a traditional costing system applies the \$160,000 of overhead costs based on direct labor hours.

- What is the total amount of overhead costs assigned to the standard model?
- What is the total amount of overhead costs assigned to the deluxe model?

Assume an activity-based costing system is used and that the number of setups and the number of components are identified as the activity-cost drivers for overhead.

- What is the total amount of overhead costs assigned to the standard model?
- What is the total amount of overhead costs assigned to the deluxe model?

Answer:

- $[\$160,000 / (650 + 150)] \times 650 = \underline{\$130,000}$
- $[\$160,000 / (650 + 150)] \times 150 = \underline{\$30,000}$
- Setups: $\$40,000 / (3 + 7) = \$4,000$ Components: $\$120,000 / (30 + 50) = \$1,500$ $(\$4,000 \times 3) + (\$1,500 \times 30) = \underline{\$57,000}$
- $(\$4,000 \times 7) + (\$1,500 \times 50) = \underline{\$103,000}$

END OF CHAPTER 5

CHAPTER 9

Inventory Costing and Capacity Analysis

تكلفة المخزون
وتحليل السعة

CH9 - ACCT335 (COST) تلخيص

ضياء الدين صبح

Inventory Costing Choices: خيارات تكلفة المخزون

✚ **Variable costing**—a method of inventory costing in which all variable manufacturing costs (direct and indirect) are included as inventoriable costs. (Also known as direct costing) – **Internal reporting to management.**

التكلفة المتغيرة - طريقة لحساب تكلفة المخزون يتم فيها تضمين جميع تكاليف التصنيع المتغيرة (المباشرة وغير المباشرة) كتكاليف قابلة للجرد. (يُعرف أيضًا باسم التكلفة المباشرة) - إعداد التقارير الداخلية للإدارة.

✚ **Absorption costing**—a method of inventory costing in which all variable and fixed manufacturing costs are included as inventoriable costs. You can say that inventory “absorbs” all manufacturing costs. **Required for external financial reporting.**

تكلفة الامتصاص - طريقة لتقدير تكلفة المخزون يتم فيها تضمين جميع تكاليف التصنيع المتغيرة والثابتة كتكاليف قابلة للجرد. يمكنك القول أن المخزون "يمتص" جميع تكاليف التصنيع. مطلوب لإعداد التقارير المالية الخارجية.

Income Statements under A.C and V.C

	VARIABLE COSTING		APSORPTION COSTING
Sales	\$xxxx	Sales	\$xxxx
less: Variable C.G.S	xxxx	less: C.G.S	xxxx
Variable marketing costs	xxxx	Gross profit	\$xxxx
Contribution margin	\$xxxx	Less: Variable marketing costs	xxxx
less: Fixed manufacturing costs	xxxx	Fixed marketing costs	xxxx
Fixed marketing costs	xxxx	Operating income	\$xxxx
Operating income	\$xxxx		

Inventory costing: Differences in Income الفرق في الدخل

✚ Operating income will differ between absorption and variable costing.

سيختلف الدخل التشغيلي بين الامتصاص والتكلفة المتغيرة.

✚ The amount of the difference represents the amount of fixed manufacturing costs capitalized as inventory under absorption costing and expensed as a period cost under variable costing.

يمثل مبلغ الفرق مبلغ تكاليف التصنيع الثابتة المرسلة كمخزون تحت حساب تكلفة الامتصاص والمصاريف كفترة تكلفة تحت التكلفة المتغيرة.

✚ If inventory levels change, operating income will differ between the two methods because of the difference in accounting for fixed manufacturing costs.

إذا تغيرت مستويات المخزون ، سيختلف الدخل التشغيلي بين الطريقتين بسبب الاختلاف في محاسبة تكاليف التصنيع الثابتة.

Example

	2017	2018
Units produced	8,000 units	8,000 units
Beginning inventory	0	2,000 units
Units sold	6,000 units	10,000 units
Ending inventory	2,000 units	0

ACTUAL PRICE AND COST DATA FOR 2017 & 2018

Selling Price	\$ 1,000
Variable manufacturing cost per unit:	
Direct materials cost per unit	\$ 110
Direct manufacturing labor cost per unit	40
Manufacturing overhead cost per unit	50
Total Variable manufacturing cost per unit	\$ 200

CH9 - ACCT335 (COST) تلخيص

ضياء الدين صبح

Variable marketing cost per unit sold	\$ 185
Fixed manufacturing costs (all indirect)	\$1,080,000
Fixed marketing costs (all indirect)	\$1,380,000

Based on the preceding information, costs per unit under the two inventory costing methods are as follows:

بناءً على المعلومات السابقة ، تكون تكاليف الوحدة وفقاً لطريقتين لتقدير تكلفة المخزون كما يلي:

	Variable Costing	Absorption Costing
V.C per unit produced		
DM	\$110	\$110
DL	40	40
Manufacturing OH	50	50
Fixed cost per unit produced	-	135*
Total inventoriable cost per unit produced	\$200	\$335

$$*(1080,000/8,000) = \$135$$

Income Statements under A.C and V.C for 2017		Income Statements under A.C and V.C for 2018	
	2017		2018
	APSORPTION COSTING		APSORPTION COSTING
Sales	\$6,000,000	Sales	\$10,000,000
less: C.G.S	<u>2,010,000</u>	less: C.G.S	<u>3,350,000</u>
Gross profit	\$3,990,000	Gross profit	\$6,650,000
Less: Variable marketing costs	1,110,000	less: Variable marketing costs	1,850,000
Fixed marketing costs	<u>1,380,000</u>	Fixed marketing costs	<u>1,380,000</u>
Operating income	\$1,500,000	Operating income	\$3,420,000
	VARIABLE COSTING		VARIABLE COSTING
Sales	\$6,000,000	Sales	\$10,000,000
less: Variable C.G.S	1,200,000	less: Variable C.G.S	2,000,000
Variable marketing costs	<u>1,110,000</u>	Variable marketing costs	<u>1,850,000</u>
Contribution margin	\$3,690,000	Contribution margin	\$6,150,000
less: Fixed manufacturing costs	1,080,000	less: Fixed manufacturing costs	1,080,000
Fixed marketing costs	<u>1,380,000</u>	Fixed marketing costs	<u>1,380,000</u>
Operating income	\$1,230,000	Operating income	\$3,690,000

Comparing Variable Costing and Absorption costing مقارنة التكلفة المتغيرة وتكلفة الإمتصاص

	Variable Costing	Absorption Costing
Are fixed OH inventoried?	No	Yes
How do changes in unit inventory levels affect operating income?		
Production = Sales	Equal	Equal
Production higher than Sales	Lower	Higher
Production lower than Sales	Higher	Lower

الأسئلة الإضافية Additional Question

Q1: Circle the correct answer

1. Which of the following cost(s) are inventoried when using variable costing?
 - a. **direct manufacturing costs**
 - b. variable marketing costs
 - c. fixed manufacturing costs
 - d. Both A and B are correct.

2. Which of the following cost(s) are inventoried when using absorption costing?
 - a. direct manufacturing costs
 - b. variable marketing costs
 - c. fixed manufacturing costs
 - d. **Both A and C are correct.**

3. _____ is a method of inventory costing in which all variable manufacturing costs (direct and indirect) are included as inventoriable costs and all fixed manufacturing costs are excluded.
 - a. **Variable costing**
 - b. Mixed costing
 - c. Absorption costing
 - d. Standard costing

4. **Absorption costing:**
 - a. expenses marketing costs as cost of goods sold
 - b. treats direct manufacturing costs as a period cost
 - c. **includes fixed manufacturing overhead as an inventoriable cost**
 - d. is required for internal reports to managers

5. **Variable costing:**
 - a. expenses administrative costs as cost of goods sold
 - b. **treats direct manufacturing costs as a product cost**
 - c. includes fixed manufacturing overhead as an inventoriable cost
 - d. is required for external reporting to shareholders

6. _____ method(s) include(s) fixed manufacturing overhead costs as inventoriable costs.
 - a. Variable costing
 - b. **Absorption costing**
 - c. Throughput costing
 - d. All of these answers are correct.

7. _____ is a method of inventory costing in which only variable manufacturing costs are included as inventoriable costs.
 - a. Fixed costing
 - b. **Variable costing**
 - c. Absorption costing
 - d. Mixed costing

8. **The only difference between variable and absorption costing is the expensing of:**
 - a. direct manufacturing costs
 - b. variable marketing costs
 - c. **fixed manufacturing costs**
 - d. Both A and C are correct

ضياء الدين صبح

Answer the following questions using the information below:

Kory's Auto produces and sells an auto part for \$60.00 per unit. In 2011, 100,000 parts were produced and 75,000 units were sold. Other information for the year includes:

Direct materials	\$24.00 per unit
Direct manufacturing labor	\$ 4.50 per unit
Variable manufacturing costs	\$ 1.50 per unit
Sales commissions	\$ 6.00 per part
Fixed manufacturing costs	\$750,000 per year
Administrative expenses, all fixed	\$270,000 per year

9. What is the inventoriable cost per unit using variable costing?

- a. \$28.50
- b. \$30.00**
- c. \$36.00
- d. \$43.50

Explanation: B) $\$24.00 + \$4.50 + \$1.50 = \30.00

10. What is the inventoriable cost per unit using absorption costing?

- a. \$30.00
- b. \$36.00
- c. \$37.50**
- d. \$43.50

Explanation: C) $\$24.00 + \$4.50 + \$1.50 + (\$750,000 / 100,000) = \$37.50$

END OF CHAPTER 9

CHAPTER 15

Allocation of Support Department Costs

تخصيص تكاليف
قسم الدعم

Allocating Costs of a Supporting Department to Operating Departments

تخصيص تكاليف قسم الدعم لأقسام التشغيل

- ✘ How a company allocates its overhead and internal support costs – costs related to marketing, advertising and other internal services – among its various production departments or projects can have a big impact on how profitable those departments or projects are.
يمكن أن يكون لكيفية تخصيص الشركة لنفقاتها العامة وتكاليف الدعم الداخلي - التكاليف المتعلقة بالتسويق والإعلان والخدمات الداخلية الأخرى - بين أقسام الإنتاج أو المشاريع المختلفة تأثير كبير على مدى ربحية تلك الأقسام أو المشاريع.
- ✘ **Operating (production) department**—directly adds value to a product or service.
قسم التشغيل (الإنتاج) - يضيف قيمة مباشرة إلى منتج أو خدمة.
- ✘ **Support (service) department**—provides the services that assist other internal departments (operating departments and other support departments) in the company.
قسم الدعم (الخدمة) - يقدم الخدمات التي تساعد الأقسام الداخلية الأخرى (الإدارات التشغيلية وأقسام الدعم الأخرى) في الشركة.

Methods of Allocating Support Costs to Production Departments

طرق تخصيص تكاليف الدعم لأقسام الإنتاج

1. Direct-allocates support-department costs directly to operating departments.
يخصص مباشرة تكاليف قسم الدعم مباشرة إلى إدارات التشغيل.
2. Step-down-partially allocates support-department costs to other support departments.
يخصص التدرج إلى أسفل جزئيًا تكاليف قسم الدعم لإدارات الدعم الأخرى.
3. Reciprocal-fully allocates support-department costs to other support departments.
يخصص بشكل متبادل بالكامل تكاليف إدارة الدعم لإدارات الدعم الأخرى.

توضيح كل طريقة

1. **Direct-allocates support-department costs directly to operating departments.**

support-department = s Operating (production) department = P1

S1	➔	P1, P2
S2	➔	P1, P2

2. **Step-down-partially allocates support-department costs to other support departments.**

S2	➔	S1, P1, P2
S1	➔	P1, P2

3. **Reciprocal-fully allocates support-department costs to other support departments.**

S1	➔	S2, P1, P2
S2	➔	S1, P1, P2

Direct Method الطريقة المباشرة

- ✘ Allocates support costs only to operating departments. يخصص تكاليف الدعم فقط لأقسام التشغيل
- ✘ Direct method does not allocate support-department costs to other support departments. لا تخصص الطريقة المباشرة تكاليف قسم الدعم لإدارات الدعم الأخرى.

Step-Down Method طريقة التدرج إلى أسفل

- ✘ Also called the sequential allocation method تسمى أيضًا طريقة التخصيص المتسلسل
- ✘ Allocates support-department costs to other support departments and to operating departments in a sequential manner that partially recognizes the mutual services provided among all support departments.
يخصص تكاليف قسم الدعم لإدارات الدعم الأخرى وإدارات التشغيل بطريقة متسلسلة تعترف جزئيًا بالخدمات المتبادلة المقدمة بين جميع إدارات الدعم.
- ✘ Begins with the support department that provides the highest % of its services to other support departments.
يبدأ بقسم الدعم الذي يقدم أعلى نسبة من خدماته لأقسام الدعم الأخرى

CH15 - ACCT335 (COST) تلخيص

ضياء الدين صبح

Reciprocal Method طريقة التبادل / التبادلية

- ✚ Allocates support-department costs to operating departments by fully recognizing the mutual services provided among all support departments.
يخصص تكاليف قسم الدعم لأقسام التشغيل من خلال الاعتراف الكامل بالخدمات المتبادلة المقدمة بين جميع إدارات الدعم.
- ✚ Reciprocal method fully incorporates interdepartmental relationships into the support-department cost allocation.
تدمج الطريقة التبادلية العلاقات بين الإدارات بشكل كامل في تخصيص تكلفة قسم الدعم.
- ✚ Also known as the matrix method. تُعرف أيضًا باسم طريقة المصفوفة

Overview of Methods نظرة عامة على الطرق

- ✚ Differences among the three methods' allocations increase as the magnitude of the reciprocal allocations increases and as the differences across operating departments' usage of each support department's services increase.
تزداد الفروق بين تخصيصات الطرق الثلاث مع زيادة حجم المخصصات المتبادلة ومع زيادة الاختلافات بين إدارات التشغيل في استخدام خدمات كل قسم دعم.
- ✚ Reciprocal is conceptually the most precise because it considers the mutual services provided among all support departments.
يعتبر التبادل هو الأكثر دقة من الناحية المفاهيمية لأنه يأخذ في الاعتبار الخدمات المتبادلة المقدمة بين جميع إدارات الدعم.
- ✚ Direct and step-down are simple to compute and understand. المباشر والتدرج سهل الحساب والفهم
- ✚ Direct method is widely used but as computing power to perform repeated iterations increases, more companies find the reciprocal method easier to implement.
تُستخدم الطريقة المباشرة على نطاق واسع ولكن مع زيادة قوة الحوسبة لإجراء التكرارات المتكررة ، تجد المزيد من الشركات أن الطريقة التبادلية أسهل في التنفيذ.

Ex: Data Used in Cost Allocation

	SUPPORT DEPARTMENTS		PRODUCTION DEPARTMENTS	
	Engineering and Production control (E&P)	Materials Management (MM)	Machining	Assembly
Budgeted OH costs	\$300,000	\$264,000	\$329,000	\$227,000
Support work provided:				
By E&P Percentage	-	30%	50%	20%
By MM Percentage	10%	-	20%	70%

1. Direct Allocation Method

	SUPPORT DEPARTMENTS		PRODUCTION DEPARTMENTS	
	Engineering and Production control (E&P)	Materials Management (MM)	Machining	Assembly
Budgeted OH costs	\$300,000	\$264,000	\$329,000	\$227,000
Allocation of E&P	(300,000)		214,286*	85,714
Allocation of MM		(264,000)	58,667**	205,333
Total budgeted OH of operating (production) departments	\$0	\$0	\$601953	\$518047

* 214,286 = 300,000 * 50/70

** 58,667 = 264,000 * 20/90

2. Step-Down Allocation Method

	SUPPORT DEPARTMENTS		PRODUCTION DEPARTMENTS	
	Engineering and Production control (E&P)	Materials Management (MM)	Machining	Assembly
Budgeted OH costs	\$300,000	\$264,000	\$329,000	\$227,000
Allocation of E&P	<u>(300,000)</u>	<u>90,000</u>	150,000*	60,000
Allocation of MM		<u>\$354,000</u> <u>(354,000)</u>	<u>78,667**</u>	<u>275,333</u>
Total budgeted OH of operating (production) departments	\$0	\$0	\$557,667	\$562,333

* \$150,000 = 300,000 * 50%

** \$78,667 = 354,000 * 20/90

Additional Question الأسئلة الإضافية

Q1: Circle the correct answer

- The support department allocation method that is the most widely used because of its simplicity is the:
 - step-down method
 - reciprocal allocation method
 - direct allocation method**
 - sequential allocation method
- The method that allocates costs by explicitly including all the services rendered among all support departments is the:
 - direct method
 - step-down method
 - reciprocal method**
 - sequential method
- Under which allocation method are one-way reciprocal support services recognized?
 - direct method
 - artificial cost method
 - reciprocal method
 - step-down method**
- The direct allocation method:
 - partially recognizes the services provided among support departments
 - is also referred to as the sequential method
 - is conceptually the most precise method
 - results in allocating only the support costs used by operating departments**
- The step-down allocation method:
 - typically begins with the support department that provides the highest percentage of its total services to other support departments**
 - recognizes the total amount of services that support departments provide to each other
 - allocates complete reciprocated costs
 - offers key input for outsourcing decisions

ضياء الدين صبح

6. **The reciprocal allocation method:**
 - a. is the most widely used because of its simplicity
 - b. requires the ranking of support departments in the order that the allocation is to proceed
 - c. **is conceptually the most precise**
 - d. results in allocating more support costs to operating departments than actually incurred
7. **Complete reciprocated costs:**
 - a. are less than the support department's own costs
 - b. **include the support department's costs plus any interdepartmental cost allocations**
 - c. are used for step-down allocations
 - d. are also referred to as budgeted costs

Q2: E-books, an online book retailer, has two operating departments— corporate sales and consumer sales—and two support departments—human resources and information systems. Each sales department conducts merchandising and marketing operations independently. E-books uses number of employees to allocate human resources costs and processing time to allocate information systems costs. The following data are available for September 2013:

	SUPPORT DEPARTMENTS		PRODUCTION DEPARTMENTS	
	Human Resources	Information Systems	Corporate Sales	Consumer Sales
Budgeted costs incurred before any interdepartmental cost allocations	\$72,700	\$234,400	\$998,270	\$489,860
Support work supplied by human resources department				
Budgeted number of employees	-----	21	42	28
Support work supplied by information systems department				
Budgeted processing time (in minutes)	320	-----	1,920	1,600

1. Allocate the support departments' costs to the operating departments using the direct method.
2. Rank the support departments based on the percentage of their services provided to other support departments. Use this ranking to allocate the support departments' costs to the operating departments based on the step-down method.

1.

	Support Departments		Operating Departments		Total
	HR	Info. Systems	Corporate	Consumer	
Costs Incurred	\$72,700	\$234,400	\$ 998,270	\$489,860	\$1,795,230
Alloc. of HR costs (42/70, 28/70)	(72,700)		43,620	29,080	
Alloc. of Info. Syst. costs (1,920/3,520, 1,600/3,520)		(234,400)	127,855	106,545	
	\$ 0	\$ 0	\$1,169,745	\$625,485	\$1,795,230

ضياء الدين صبح

2. Rank on percentage of services rendered to other support departments.

Step 1: HR provides 23.077% of its services to information systems:

$$\frac{21}{42 + 28 + 21} = \frac{21}{91} = 23.077\%$$

This 23.077% of \$72,700 HR department costs is \$16,777.

Step 2: Information systems provides 8.333% of its services to HR:

$$\frac{320}{1,920 + 1,600 + 320} = \frac{320}{3,840} = 8.333\%$$

This 8.333% of \$234,400 information systems department costs is \$19,533.

	Support Departments		Operating Departments		Total
	HR	Info. Systems	Corporate	Consumer	
Costs Incurred	\$72,700	\$234,400	\$ 998,270	\$489,860	\$1,795,230
Alloc. of HR costs (21/91, 42/91, 28/91)	<u>(72,700)</u>	<u>16,777</u>	33,554	22,369	
	<u>\$ 0</u>	251,177			
Alloc. of Info. Syst. costs (1,920/3,520, 1,600/3,520)		<u>(251,177)</u>	<u>137,006</u>	<u>114,171</u>	
		<u>\$ 0</u>	<u>\$1,168,830</u>	<u>\$626,400</u>	<u>\$1,795,230</u>

END OF CHAPTER 15

END OF Cost ACCOUNTING Summary

نهاية تلخيص محاسبة التكاليف
(كوست)

زميلكم : ضياء الدين صبح 

بالتوفيق زملائي 